

CDK12.5 - OPTICAL TRAIN: for SBIG STX BODY, AND MMOAG

Distance to Focuser Mounting Surface 10.445

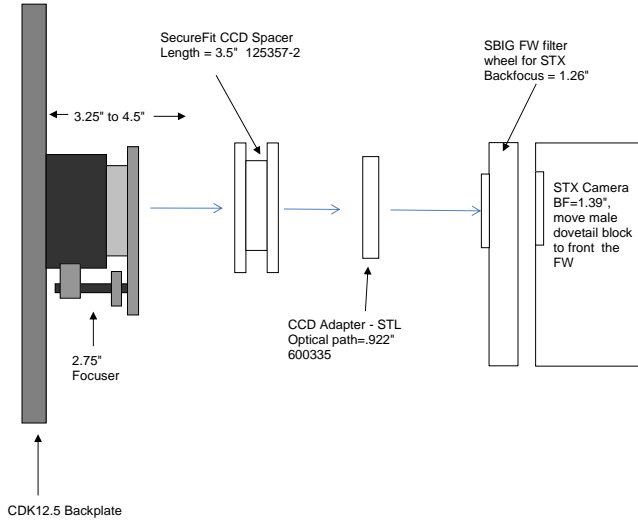

STX and FW		10.445	remaining BF
2.75" Focuser (racked in)		3.25	7.195
Focus position (0 to 1.3")		0.123	7.072
SecureFit CCD Spacer - 125357-2		3.5	3.572
CCD Adapter - STL - 600335		0.922	2.65
SBIG FW STX (w/threaded adapter ring attached)		1.26	1.39
STX Camera		1.39	0

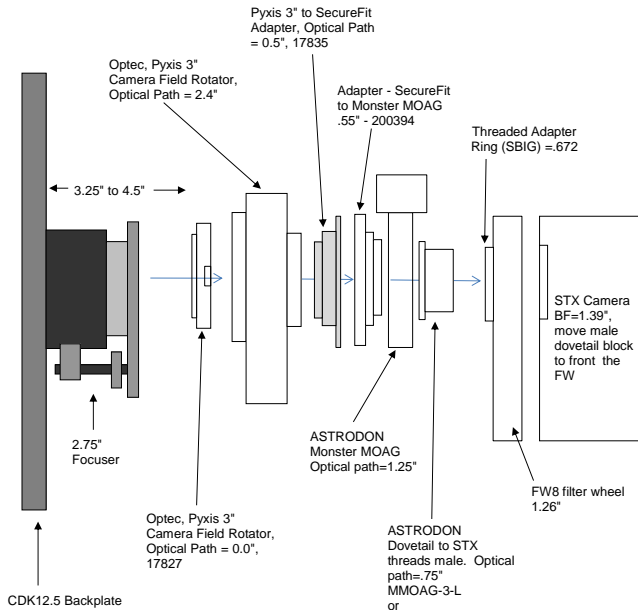

STX CCD, Pyxis & MMOAG		10.445	remaining BF
2.75" Focuser (racked in)		3.25	7.195
Focus position (0 to 1.3")		0.34	6.855
PW 12.5 to Optec-3600 dovetail adapter - 17827		0	6.855
Optec Pyxis 3" Camera Rotator		2.4	4.455
Optec Pyxis 3" to SecureFit Adapter - 17835		0.5	3.955
Adapter SecureFit to Monster MOAG - 200394		0.55	3.405
Monster MOAG - MMOAG		1.25	2.155
AstroDon Adapter - MMOAG-SLT-S		0.1	2.055
SBIG STX Camera with mounting block		2.06	0.00

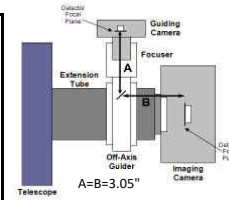

Does not reach focus without the use of custom adapters

STX CCD, FW8, Pyxis & MMOAG		10.445	remaining BF
2.75" Focuser (racked in)		3.25	7.195
Focus position (0 to 1.3")		0	7.195
PW 12.5 to Optec-3600 dovetail adapter - 17827		0	7.195
Optec Pyxis 3" Camera Rotator		2.4	4.795
Optec Pyxis 3" to SecureFit Adapter - 17835		0.5	4.295
Adapter SecureFit to Monster MOAG - 200394		0.55	3.745
Monster MOAG - MMOAG		1.25	2.495
AstroDon Adapter - MMOAG-SLT-S		0.1	2.395
SBIG FW8 Filter Wheel w/threaded adapter ring attached		1.93	0.465
SBIG STX Camera		1.39	-0.925

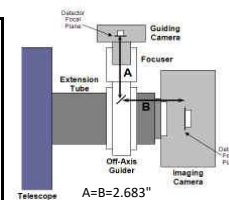

PLANEWAVE INSTRUMENTS
CDK12 SPACERS FOR STX CAMERAS

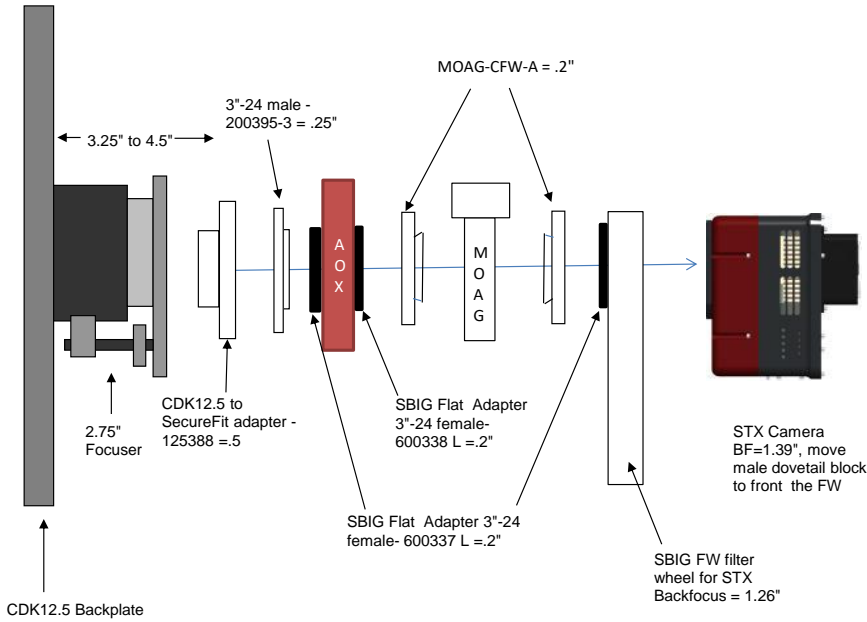

STX camera and MMOAG	10.45	remaining BF
Hedrick Focuser, 2.75"	3.25	7.2
Focuser position (0-1.3")	0.37	6.83
CDK12.5 to SecureFit - 125388	0.5	6.33
SecureFit to 3"-24 male - 200395-3	0.25	6.08
SBIG Flat Adapter (3"-24 female) - 600337	0.2	5.88
AO-X	1.18	4.7
SBIG Flat Adapter (3"-24 female) - 600338	0.2	4.5
MOAG-CWF-A	0.2	4.3
AstroDon part - MMOAG	1.25	3.05
MOAG-CWF-A	0.2	2.85
SBIG Flat Adapter (3"-24 female) - 600337	0.2	2.65
Filter Wheel, FW8	1.26	1.39
SLX Back Focus	1.39	0

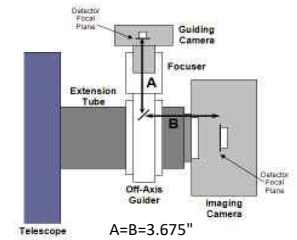

PLANEWAVE INSTRUMENTS
CDK12.5 SPACERS FOR STXL CAMERAS

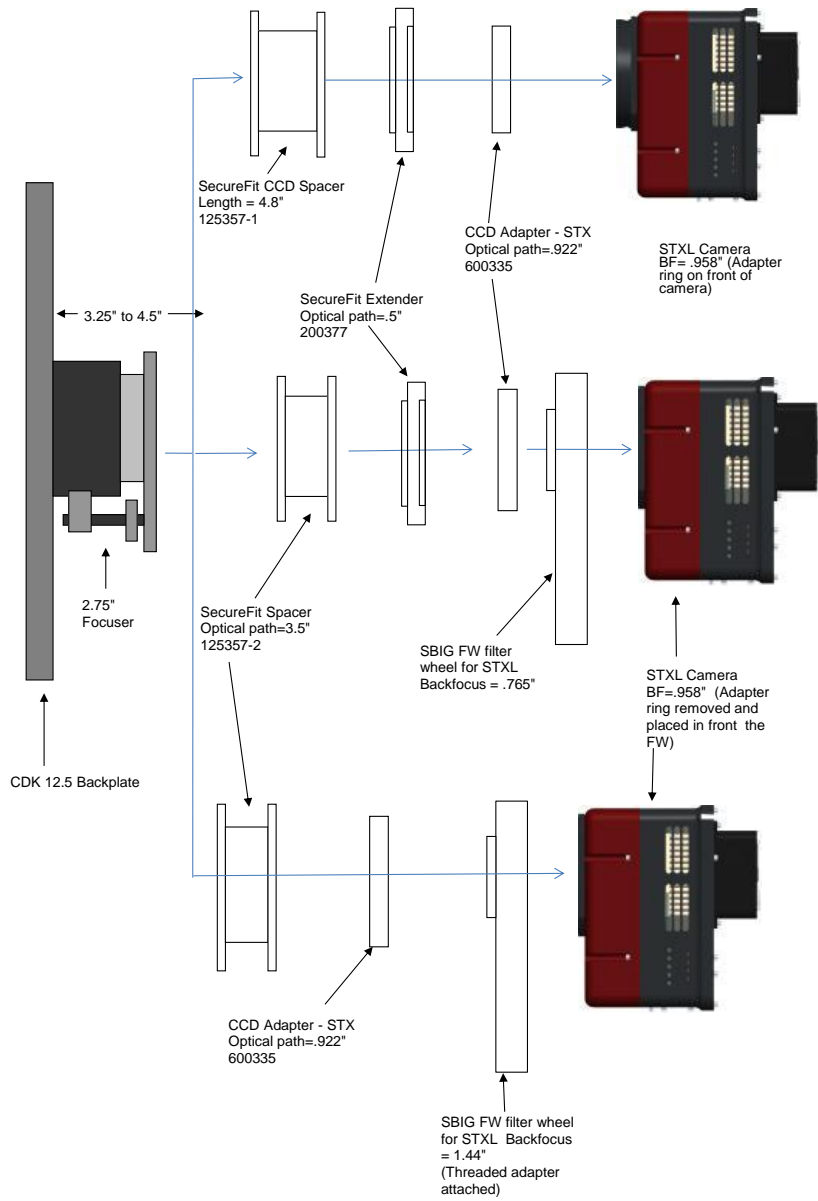

STXL	10.445	remaining BF
Focuser racked in	3.25	7.195
Focuser position (0-1.3")	0.815	6.38
CCD Spacer 4.8" - 125357-2	3.5	2.88
SecureFit Extender - 200377	0.5	2.38
SecureFit Extender - 200377	0.5	1.88
CCD Adapter STX - 600335	0.922	0.958
STXL Back Focus (w/Threaded Adapter attached)	0.958	0

STXL w/ Standard FW	10.445	remaining BF
Focuser racked in	3.25	7.195
Focuser position (0-1.3")	0.55	6.645
SecureFit CCD Spacer - 125357-2	3.5	3.145
SecureFit Extender - 200377	0.5	2.645
CCD Adapter STX - 600335	0.922	1.723
Filter Wheel (w/Threaded Adapter Ring attached)	0.765	0.958
STXL Back Focus	0.958	0

STXL w/ Self Guiding FW	10.445	remaining BF
Focuser racked in	3.25	7.195
Focuser position (0-1.3")	0.375	6.82
SecureFit CCD Spacer - 125357-2	3.5	3.32
CCD Adapter STX - 600335	0.922	2.398
Filter Wheel, Self Guiding w/threaded adapter ring attached	1.44	0.958
STXL Back Focus	0.958	0

PLANEWAVE INSTRUMENTS
 SECUREFIT CCD SPACERS FOR ST CAMERAS
 for CDK12.5

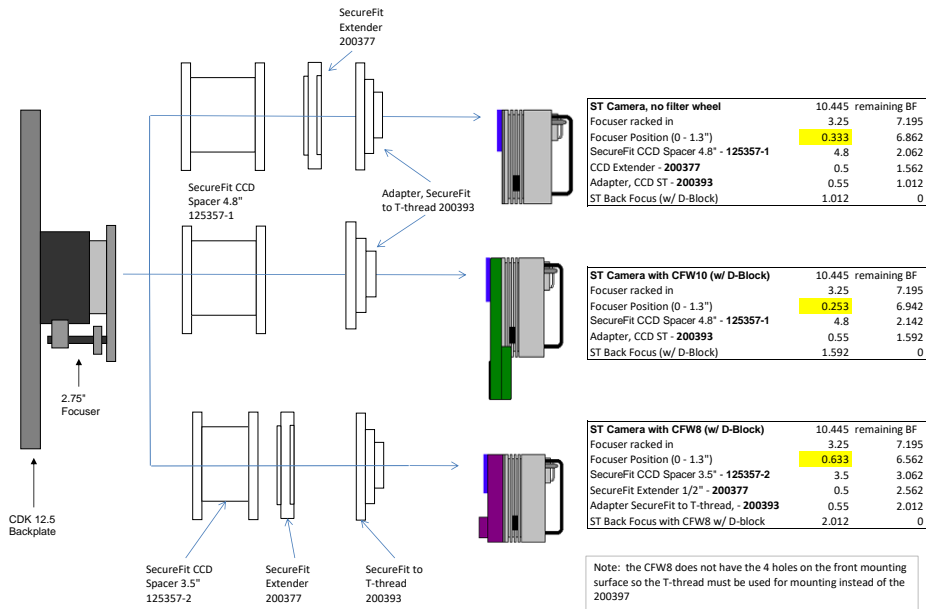

PLANEWAVE INSTRUMENTS
 SECUREFIT CCD SPACERS FOR ST CAMERAS
 for CDK12.5

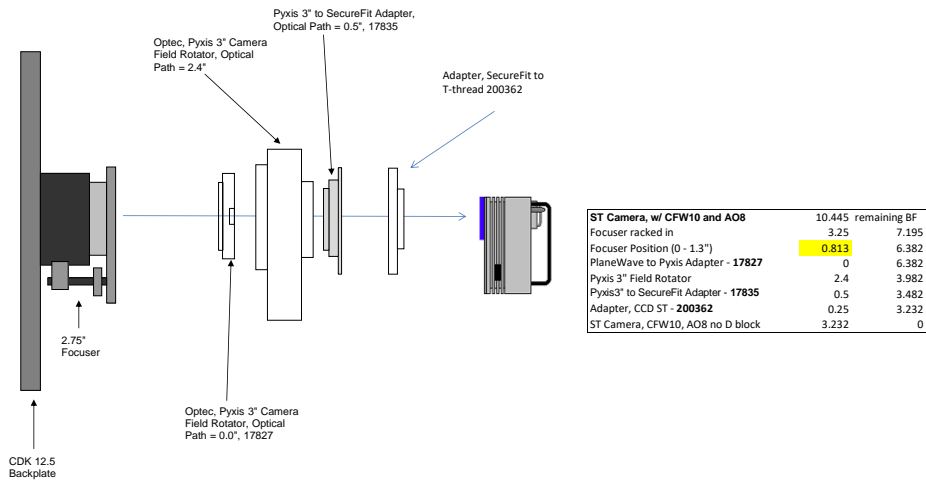

PLANEWAVE INSTRUMENTS
2" CCD SPACERS FOR ST CAMERAS
 for CDK12.5

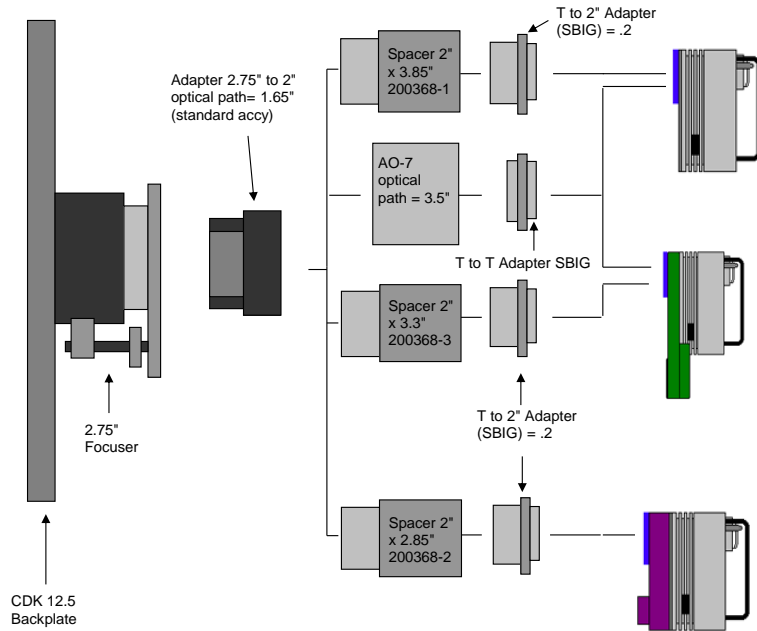

ST Camera, no filter wheel		
10.445 remaining BF		
Focuser racked in	3.25	7.195
Focuser Position (0 - 1.3")	0.483	6.712
Adapter, 2.75 to 2 (standard accy)	1.65	5.062
CCD 2" Spacer x 3.85" - 200368-1	3.85	1.212
T to 2 Adapter (SBIG)	0.2	1.012
ST Back Focus (with D-Block)	1.012	0

ST Camera + AO-7		
10.445 remaining BF		
Focuser racked in	3.25	7.195
Focuser Position (0 - 1.3")	0.835	6.36
Adapter, 2.75 to 2 (standard accy)	1.65	4.71
T to T Adapter (SBIG)	0.2	4.51
ST + AO-7 backfocus	4.51	0

ST Camera with CFW10 w/ D-Block		
10.445 remaining BF		
Focuser racked in	3.25	7.195
Focuser Position (0 - 1.3")	0.453	6.742
Adapter, 2.75 to 2 (standard accy)	1.65	5.092
CCD 2" SPACER x 3.3" - 200368-3	3.3	1.792
T to 2 Adapter (SBIG)	0.2	1.592
ST Back Focus (with D-Block)	1.592	0

ST + CFW10 + AO-7		
10.445 remaining BF		
Focuser racked in	3.25	7.195
Focuser Position (0 - 1.3")	0.255	6.94
Adapter, 2.75 to 2 (standard accy)	1.65	5.29
T to T Adapter (SBIG)	0.2	5.09
ST + AO-7 backfocus	5.09	0

ST Camera with CFW8 w/ D-Block		
10.445 remaining BF		
Focuser racked in	3.25	7.195
Focuser Position (0 - 1.3")	0.483	6.712
Adapter, 2.75 to 2 (standard accy)	1.65	5.062
CCD 2" Spacer x 2.85" - 200368-2	2.85	2.212
T to 2 Adapter (SBIG)	0.2	2.012
ST Back Focus (with D-block)	2.012	0

DOES NOT HAVE ENOUGH BACK FOCUS		
10.445 remaining BF		
Focuser racked in	3.25	7.195
Focuser Position (0 - 1.3")	0	7.195
Adapter, 2.75 to 2 (standard accy)	1.65	5.545
T to 2 Adapter (SBIG)	0.2	5.345
ST + AO-7 backfocus	5.51	-0.165

PLANEWAVE INSTRUMENTS
CDK12.5 SECUREFIT SPACERS FOR STT CAMERAS

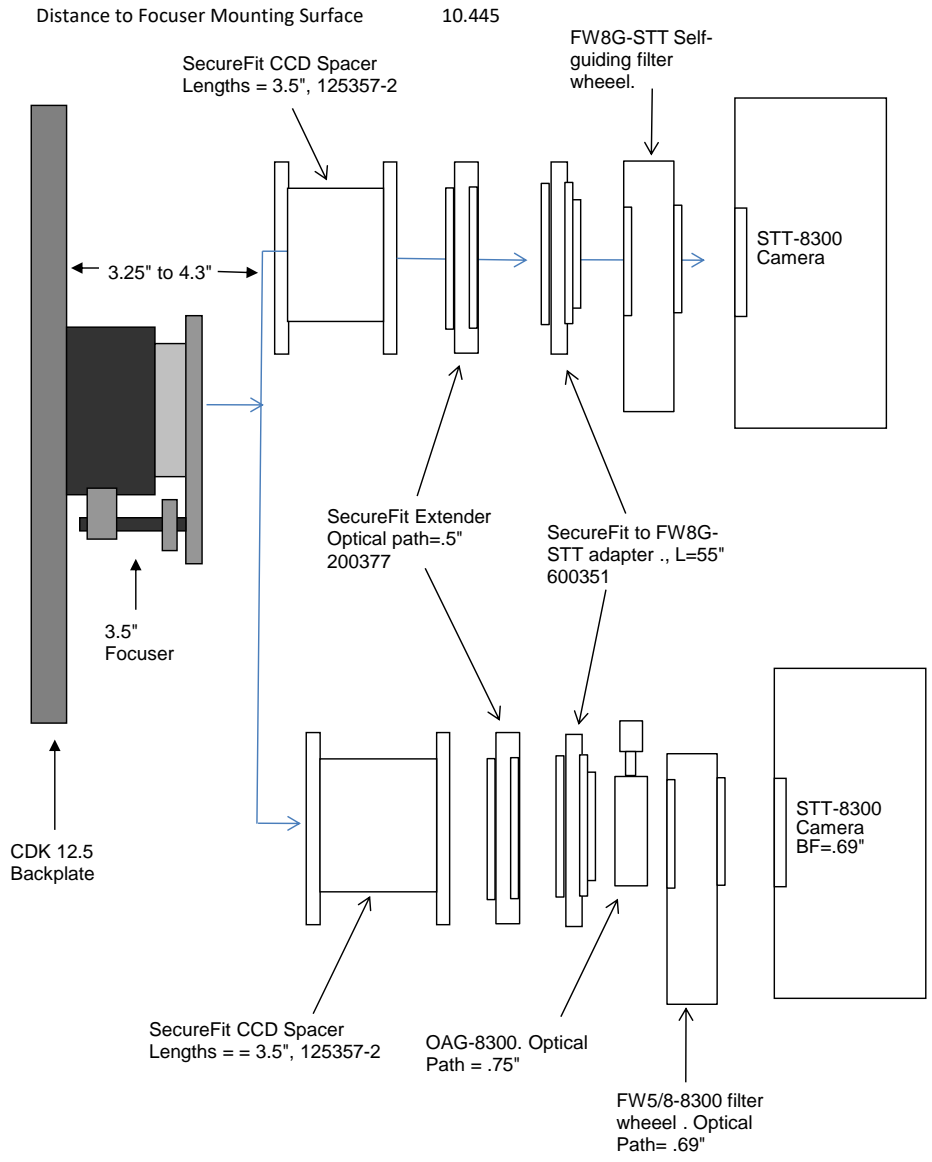

STT8300 Camera w/ Self Guiding Filter Wheel	10.445	remaining BF
Focuser racked in	3.25	7.195
Focuser position (0-1.3")	0.517	6.678
SecureFit Spacer 3.5- 125357-2	3.5	3.178
CCD SecureFit Extender - 200377	0.5	2.678
SecureFit to FW8G-STT - 600351	0.55	2.128
FW8G-SST attached to STT-8300 Camera	2.128	0

STT8300 Camera w/Filter Wheel, OAG8300	10.445	remaining BF
Focuser racked in	3.25	7.195
Focuser position (0-1.3")	0.415	6.78
SecureFit Spacer 3.5- 125357-2	3.5	3.28
CCD SecureFit Extender - 200377	0.5	2.78
SecureFit to FW8G-STT - 600351	0.55	2.23
OAG-8300	0.75	1.48
FW5-8300 / FW8-8300	0.79	0.69
STT-8300 Camera	0.69	0

PLANEWAVE INSTRUMENTS
SECUREFIT CCD SPACERS FOR STL CAMERAS
 for CDK12.5

← 10.445 →
 Distance from focuser mounting surface to focal plane

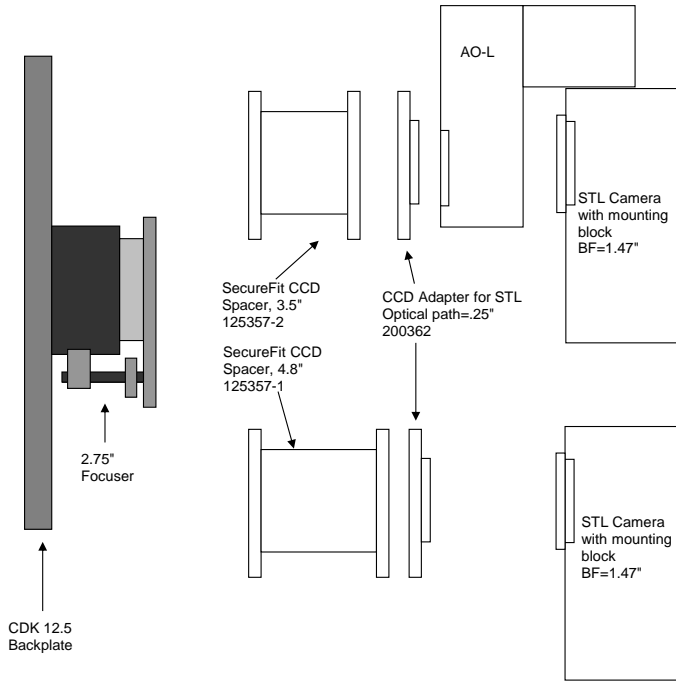

STL and AO-L required spacers	10.445 remaining BF	
2.75" Focuser (racked in)	3.25	7.195
Focus position (0 to 1.3")	0.485	6.71
SecureFit CCD Spacer 3.5" - 125357-2	3.5	3.21
CCD Adapter, STL - 200362	0.25	2.96
AO-L	1.49	1.47
STL Back Focus	1.47	0

STL Camera	10.445 remaining BF	
2.75" Focuser (racked in)	3.25	7.195
Focus position (0 to 1.3")	0.675	6.52
SecureFit CCD Spacer 4.8" - 125357-1	4.8	1.72
CCD Adapter, STL - 200362	0.25	1.47
STL Back Focus	1.47	0

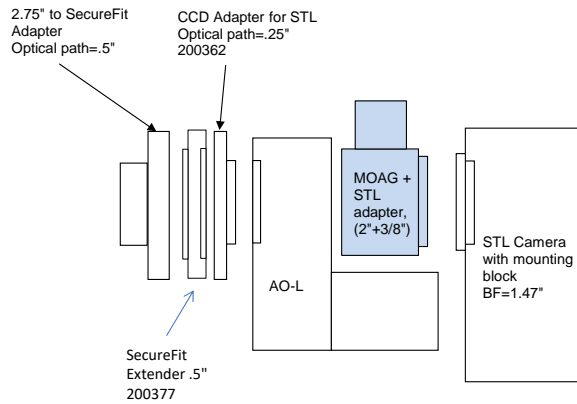

STL, AO-L and MOAG	10.445 remaining BF	
2.75" Focuser (racked in)	3.25	7.195
Focus position (0 to 1.3")	0	7.195
2.75" to SecureFit	0.5	6.695
SecureFit Extender - 200377	0.5	6.195
CCD Adapter, STL - 200362	0.25	5.945
AO-L	1.49	4.455
MOAG from Astrodon (2" of backfocus)	2	2.455
MOAG to SLT Adapter (3/8")	0.375	2.08
STL Back Focus	1.509	0.571

PLANEWAVE INSTRUMENTS
SECUREFIT CCD SPACERS FOR STL CAMERAS
for CDK12.5

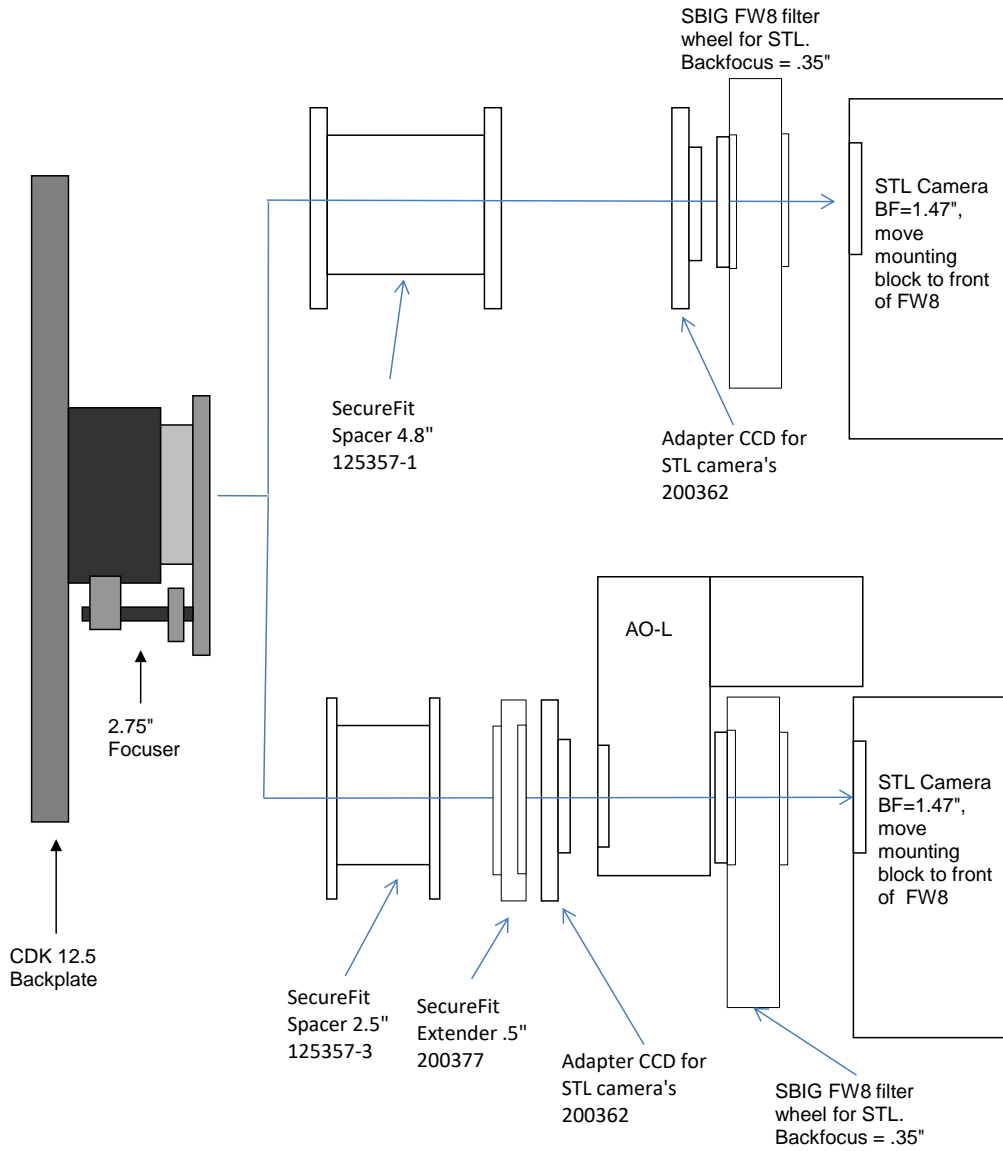

STL w/ FW8		10.445 remaining BF
Focuser racked in	3.25	7.195
Focus position (0 to 1.3")	0.325	6.87
SecureFit CCD Spacer 4.8" - 125357-1	4.8	2.07
CCD Adapter, STL - 200362	0.25	1.82
FW8	0.35	1.47
SLT Back Focus	1.47	0

STL + FW8 + AO-L		10.445 remaining BF
Focuser racked in	3.25	7.195
Focus position (0 to 1.3")	0.635	6.56
SecureFit CCD Spacer 2.5" - 125357-3	2.5	4.06
SecureFit CCD Extender .5" - 200377	0.5	3.56
CCD Adapter, STL - 200362	0.25	3.31
AO-L	1.49	1.82
FW8	0.35	1.47
SLT Back Focus	1.47	0

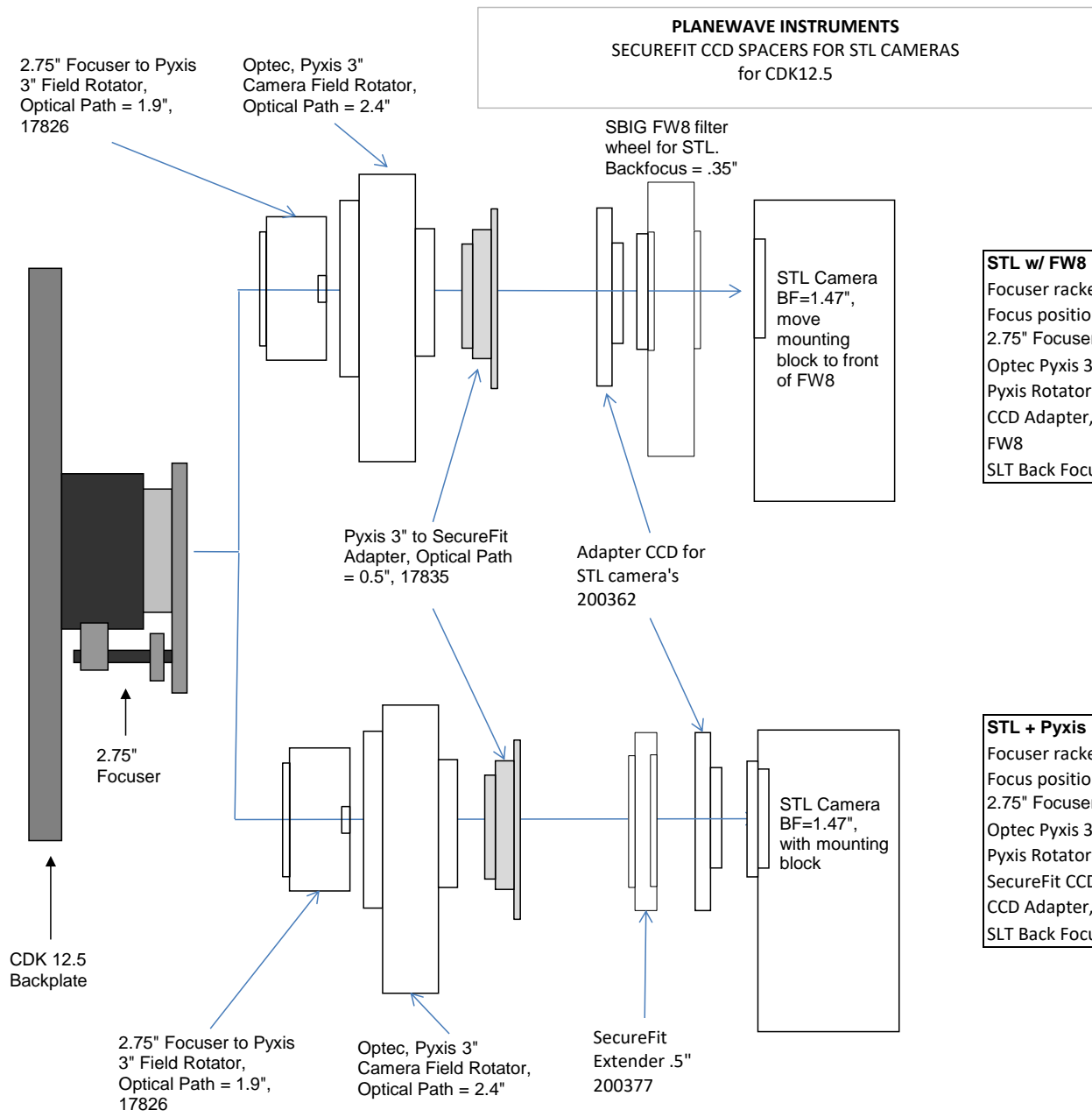

STL w/ FW8	10.445 remaining BF	
Focuser racked in	3.25	7.195
Focus position (0 to 1.3")	0.325	6.87
2.75" Focuser to Pyxis Rotator - 17826	1.9	4.97
Optec Pyxis 3" Rotator - PYXIS 3	2.4	2.57
Pyxis Rotator to SecureFit - 17835	0.5	2.07
CCD Adapter, STL - 200362	0.25	1.82
FW8	0.35	1.47
SLT Back Focus	1.47	0

STL + Pyxis	10.445 remaining BF	
Focuser racked in	3.25	7.195
Focus position (0 to 1.3")	0.175	7.02
2.75" Focuser to Pyxis Rotator - 17826	1.9	5.12
Optec Pyxis 3" Rotator - PYXIS 3	2.4	2.72
Pyxis Rotator to SecureFit - 17835	0.5	2.22
SecureFit CCD Extender .5" - 200377	0.5	1.72
CCD Adapter, STL - 200362	0.25	1.47
SLT Back Focus	1.47	0

CDK12.5 - OPTICAL TRAIN: for SBIG STL BODY, AND MMOAG

Distance to Focuser Mounting Surface 10.445

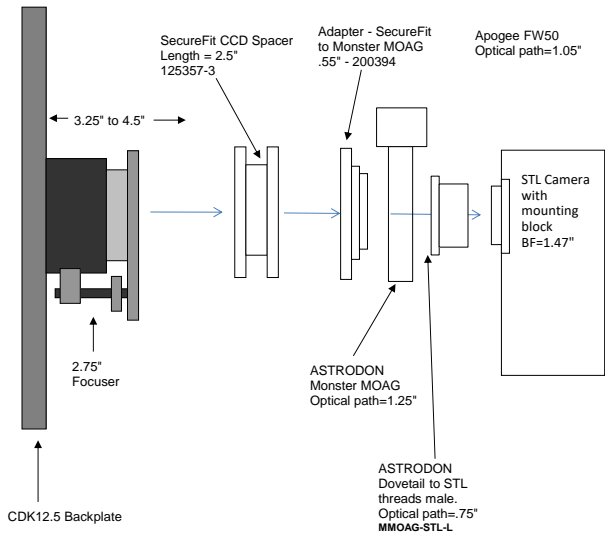

STL CCD & MMOAG		10.445	remaining BF
2.75" Focuser (racked in)		3.25	7.195
Focus position (0 to 1.3")		0.675	6.52
SecureFit CCD Spacer - 125357-3		2.5	4.02
Adapter SecureFit to Monster MOAG - 200394		0.55	3.47
Monster MOAG - MMOAG		1.25	2.22
AstroDon Adapter - MMOAG-STL-L		0.75	1.47
SBIG STL Camera with mounting block		1.47	0

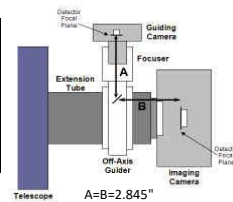

STL CCD, FW8 FILTER WHEEL & MMOAG		10.445	remaining BF
2.75" Focuser (racked in)		3.25	7.195
Focus position (0 to 1.3")		0.475	6.72
SecureFit CCD Spacer - 125357-3		2.5	4.22
Adapter SecureFit to Monster MOAG - 200394		0.55	3.67
SecureFit Spacer 0.5" - 200377		0.5	3.17
Monster MOAG - MMOAG		1.25	1.92
AstroDon Adapter - MMOAG-STL-S		0.1	1.82
SBIG FW8 Filter Wheel		0.35	1.47
SBIG STL Camera with mounting block		1.47	0

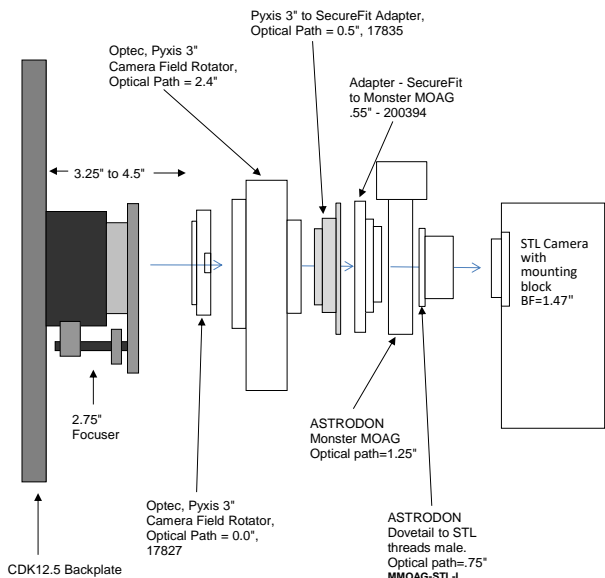
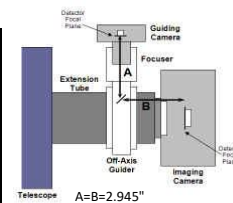

STL CCD, Pyxis & MMOAG		10.445	remaining BF
2.75" Focuser (racked in)		3.25	7.195
Focus position (0 to 1.3")		0.275	6.92
PW 12.5 to Optec-3600 dovetail adapter - 17827		0	6.92
Optec Pyxis 3" Camera Rotator		2.4	4.52
Optec Pyxis 3" to SecureFit Adapter - 17835		0.5	4.02
Adapter SecureFit to Monster MOAG - 200394		0.55	3.47
Monster MOAG - MMOAG		1.25	2.22
AstroDon Adapter - MMOAG-STL-L		0.75	1.47
SBIG STL Camera with mounting block		1.47	0

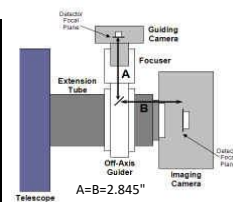

STL CCD, FW8, Pyxis & MMOAG		10.445	remaining BF
2.75" Focuser (racked in)		3.25	7.195
Focus position (0 to 1.3")		0.575	6.62
PW 12.5 to Optec-3600 dovetail adapter - 17827		0	6.62
Optec Pyxis 3" Camera Rotator		2.4	4.22
Optec Pyxis 3" to SecureFit Adapter - 17835		0.5	3.72
Adapter SecureFit to Monster MOAG - 200394		0.55	3.17
Monster MOAG - MMOAG		1.25	1.92
AstroDon Adapter - MMOAG-STL-S		0.1	1.82
SBIG FW8 Filter Wheel		0.35	1.47
SBIG STL Camera with mounting block		1.47	0

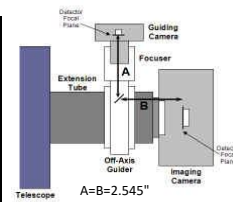

PLANEWAVE INSTRUMENTS
CDK14 SPACERS FOR STX CAMERAS

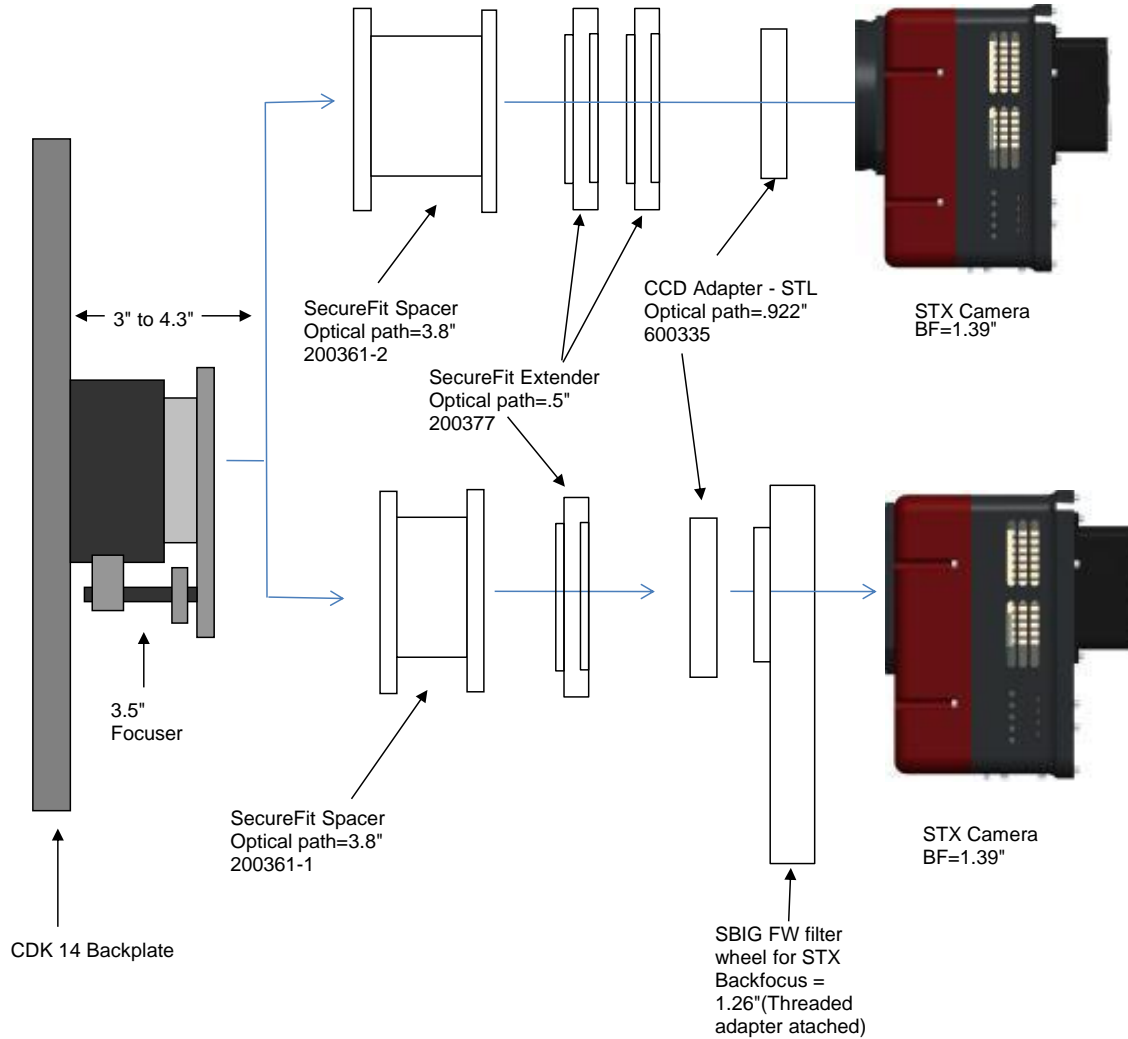

STX	11.09 remaining BF	
Focuser racked in	3	8.09
Focuser position (0-1.3")	0.278	7.812
CCD Spacer 4.5" - 200361-3	4.5	3.312
CCD SecureFit Extender - 200377	0.5	2.812
CCD SecureFit Extender - 200377	0.5	2.312
CCD Adapter STX - 600335	0.922	1.39
STX Back Focus w/ mounting adapter	1.39	0

STX w/ FW	11.09 remaining BF	
Focuser racked in	3	8.09
Focuser position (0-1.3")	0.218	7.872
CCD Spacer 3.8" - 200361-1	3.8	4.072
SecureFit Extender - 200377	0.5	3.572
CCD Adapter STX - 600335	0.922	2.65
Filter Wheel (w/threaded adapter ring attached)	1.26	1.39
STX Back Focus	1.39	0

PLANEWAVE INSTRUMENTS
CDK14 SPACERS FOR STX CAMERAS

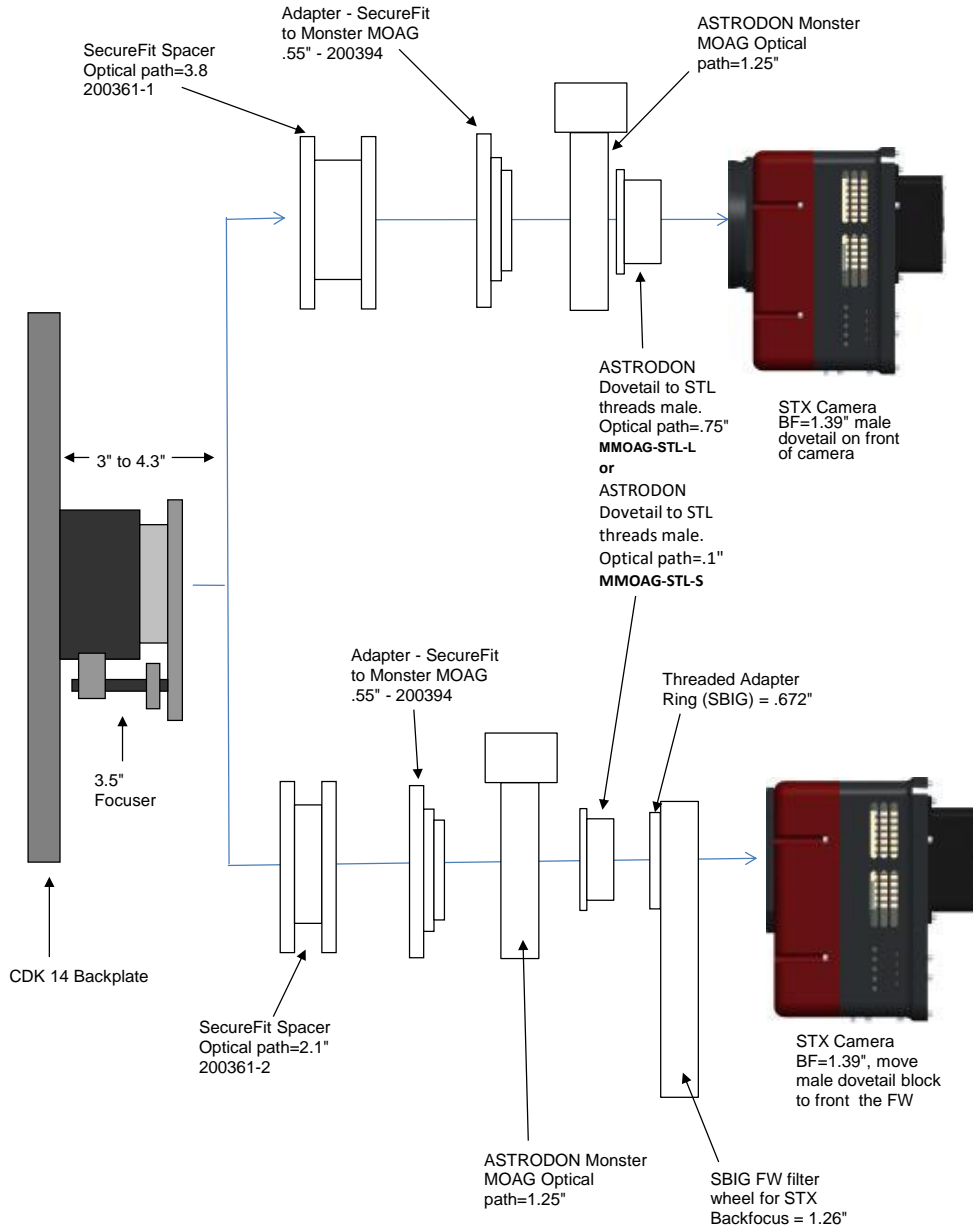

STX camera and MMOAG		11.09 remaining BF
Focuser racked in	3	8.09
Focuser position (0-1.3")	0.35	7.74
CCD Spacer 3.8 - 200361-1	3.8	3.94
CCD SecureFit to MMOAG - 200394	0.55	3.39
AstroDon part - MMOAG	1.25	2.14
MMOAG-STL-L	0.75	1.39
STX Back Focus	1.39	0

STX camera and MMOAG		11.09 remaining BF
Focuser racked in	3	8.09
Focuser position (0-1.3")	0.5	7.59
CCD Spacer 2.1 - 200361-2	3.8	3.79
SecureFit Extender - 200377	0.5	3.29
CCD SecureFit to MMOAG - 200394	0.55	2.74
AstroDon part - MMOAG	1.25	1.49
AstroDon part - MMOAG-STL-S	0.1	1.39
SLT Back Focus	1.39	0

STX camera and MMOAG		11.09 remaining BF
Focuser racked in	3	8.09
Focuser position (0-1.3")	0.77	7.32
CCD Spacer 2.1 - 200361-2	2.1	5.22
CCD SecureFit to MMOAG - 200394	0.55	4.67
AstroDon part - MMOAG	1.25	3.42
AstroDon part - MMOAG-STL-S	0.1	3.32
Filter Wheel, FW8	1.93	1.39
SLX Back Focus	1.39	0

PLANEWAVE INSTRUMENTS
CDK14 SPACERS FOR STX CAMERAS & AO-X

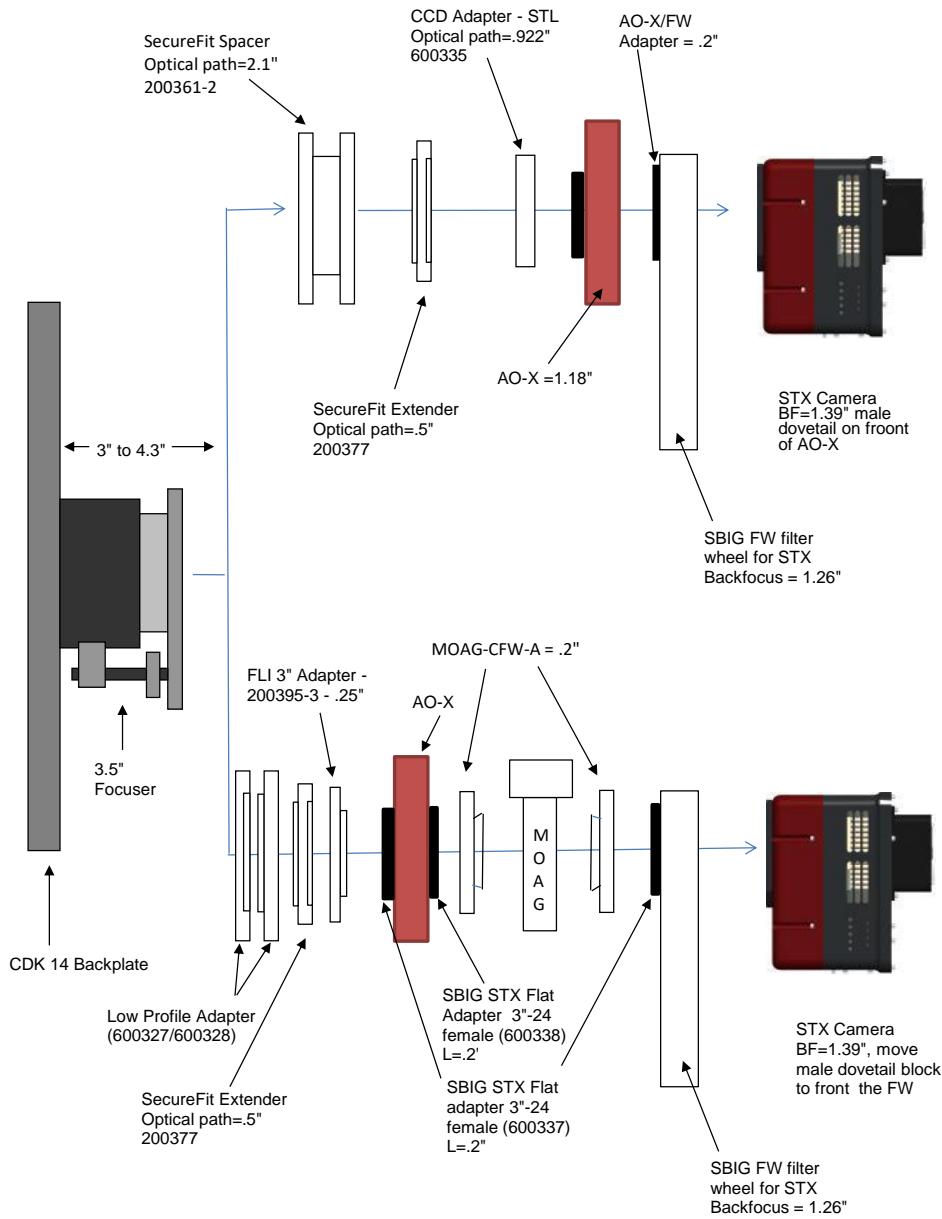

STX camera, AO-X, CFW		11.09 remaining BF
Focuser racked in	3	8.09
Focuser position (0-1.3")	0.34	7.75
SecureFit Spacer- 200361-2	2.1	5.65
SecureFit 1/2" Spacer - 200377	0.5	5.15
CCD SecureFit to STL - 600335	0.922	4.23
AO-X (W/ Threaded adapter attached)	1.38	2.85
AO-X to FW Adapter	0.2	2.65
SBIG Filter Wheel	1.26	1.39
STX Back Focus	1.39	0.00

STX camera and MMOAG		11.09 remaining BF
Focuser racked in	3	8.09
Focuser position (0-1.3")	0.76	7.33
Low profile adapters- 600327/328	0.5	6.83
SecureFit 1/2" Spacer - 200377	0.5	6.33
SecureFit to 3"-24 male (FLI and SBIG) - 200395-3	0.25	6.08
SBIG Flat Adapter (3"-24 female) - 600337	0.2	5.88
AO-X	1.18	4.7
SBIG Flat Adapter (3"-24 female) - 600338	0.2	4.5
MOAG-CWF-A	0.2	4.3
AstroDon part - MMOAG	1.25	3.05
MOAG-CWF-A	0.2	2.85
SBIG Flat Adapter (3"-24 female) - 600337	0.2	2.65
Filter Wheel, FW8	1.26	1.39
SLX Back Focus	1.39	0

PLANEWAVE INSTRUMENTS
CDK14 SPACERS FOR STX CAMERAS with STX Guider

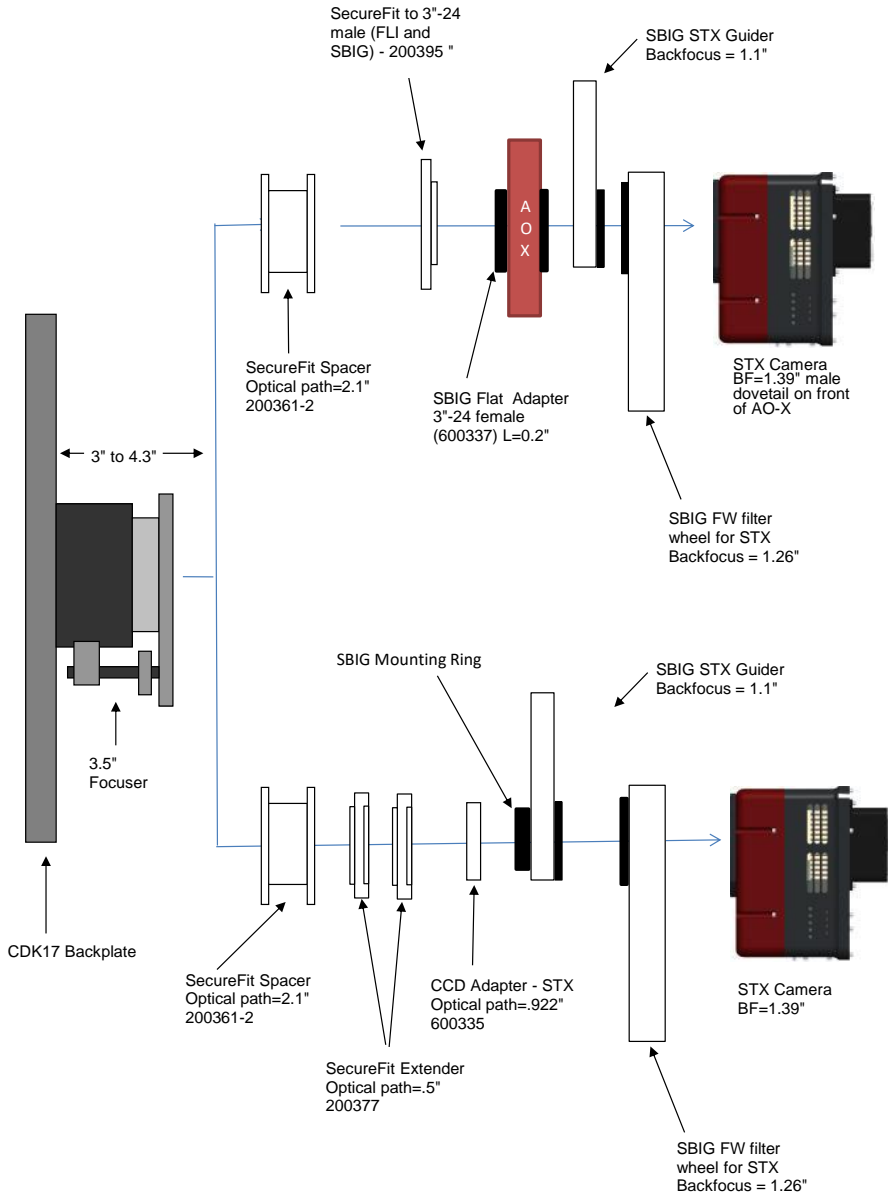

STX camera, AO-X, CFW, STX Guider	11.09 remaining BF	
Focuser racked in	3	8.09
Focuser position (0-1.3")	0.41	7.68
SecureFit Adapter 2.1 - 200361-2	2.1	5.58
CCD SecureFit 3-24 - 200395-3	0.25	5.33
SBIG Flat adapter 3"-24 - 600337	0.2	5.13
AO-X	1.18	3.95
AO-X to FW adapter (SBIG)	0.2	3.75
STX Guider	1.1	2.65
SBIG Filter Wheel	1.26	1.39
STX Back Focus	1.39	0

STX camera, AO-X, CFW, STX Guider w/IRF90	11.09 remaining BF	
IRF 90 Focuser racked in	3.5	7.59
Focuser position (0-1.3")	0.468	7.122
Low Profile Adapter (focuser) - 600327	0.25	6.872
Low Profile Adapter (camera) - 600328	0.25	6.622
SecureFit Extender - 200377	0.5	6.122
STX/STXL to SecureFit adapter - 600335	0.992	5.13
AO-X w/camera mounting ring attached	1.18	3.95
AO-X to FW adapter (SBIG)	0.2	3.75
STX Guider	1.1	2.65
SBIG Filter Wheel	1.26	1.39
STX Back Focus	1.39	0

STX camera, CFW, STX Guider	11.09 remaining BF	
Focuser racked in	3	8.09
Focuser position (0-1.3")	0.318	7.772
SecureFit Adapter 2.1 - 200361-2	2.1	5.672
SecureFit Extender - 200377	0.5	5.172
SecureFit Extender - 200377	0.5	4.672
STX/STXL to SecureFit adapter - 600335	0.922	3.75
STX Guider w/camera mounting ring attached	1.1	2.65
SBIG Filter Wheel	1.26	1.39
STX Back Focus	1.39	0

STX camera, CFW, STX Guider w/ IRF90	11.09 remaining BF	
IRF 90 racked in	3.5	7.59
Focuser position (0-1.3")	0.74	6.85
SecureFit Adapter 2.1 - 200361-2	2.1	4.75
SecureFit Extender - 200377	0.5	4.25
SecureFit to 3"-24 male (FLI and SBIG) - 200395-3	0.25	4
SBIG Flat Adapter (3"-24 female) - 600337	0.25	3.75
STX Guider	1.1	2.65
SBIG Filter Wheel	1.26	1.39
STX Back Focus	1.39	0

CDK14- OPTICAL TRAIN: for SBIG STX BODY, AND MMOAG

Distance to Focuser Mounting Surface 11.09

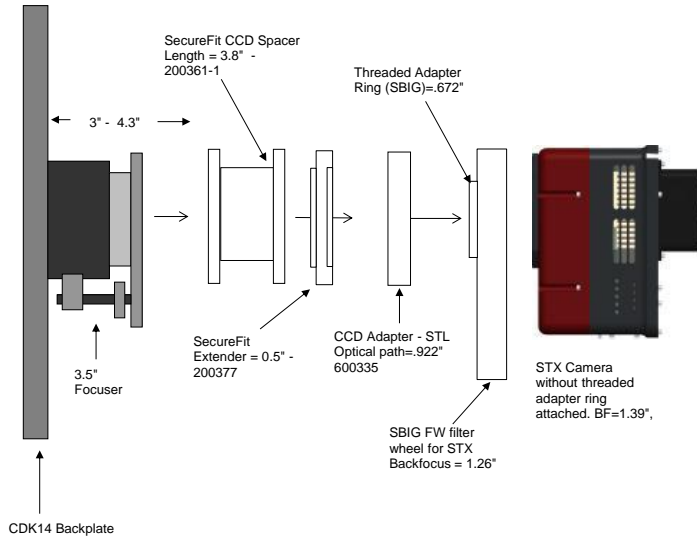

STX and FW		11.09 remaining BF
Focuser (racked in)	3	8.09
Focus position (0 to 1.3")	0.218	7.872
SecureFit CCD Spacer - 200361-1	3.8	4.072
SecureFit Extender - 200377	0.5	3.572
CCD Adapter - STL - 600335	0.922	2.65
SBIG FW STX (w/ threaded adapter ring attached)	1.26	1.39
STX Camera	1.39	0

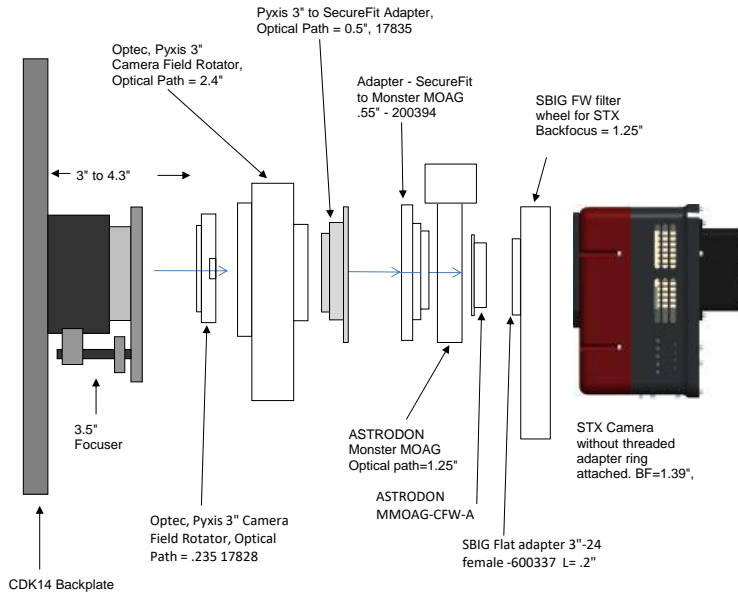

STL CCD, Pyxis & MMOAG		11.09 remaining BF
Focuser (racked in)	3	8.09
Focus position (0 to 1.3")	0.595	7.495
PW 14/17/20 to Optec-3600 dovetail adapter - 17828	0.235	7.26
Optec Pyxis 3" Camera Rotator	2.4	4.86
Optec Pyxis 3" to SecureFit Adapter - 17835	0.5	4.36
Adapter SecureFit to Monster MOAG - 200394	0.55	3.81
Monster MOAG - MMOAG	1.25	2.56
AstroDon Adapter - MMOAG-SLT-M	0.5	2.06
SBIG STX Camera with threaded adapter ring attached	2.06	0

STL CCD, FW8, Pyxis & MMOAG		11.09 remaining BF
Focuser (racked in)	3	8.09
Focus position (0 to 1.3")	0.115	7.975
PW 14/17/20 to Optec-3600 dovetail adapter - 17828	0.235	7.74
Optec Pyxis 3" Camera Rotator	2.4	5.34
Optec Pyxis 3" to SecureFit Adapter - 17835	0.5	4.84
Adapter SecureFit to Monster MOAG - 200394	0.55	4.29
Monster MOAG - MMOAG	1.25	3.04
AstroDon Adapter - MMOAG-CFW-A	0.2	2.84
SBIG Flat adapter 3"-24 female - 600337	0.2	2.64
SBIG FW8 Filter Wheel	1.25	1.39
SBIG STX Camera without threaded adapter ring	1.39	0

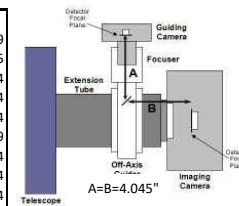
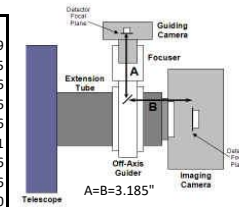

PLANEWAVE INSTRUMENTS
CDK14 SPACERS FOR STXL CAMERAS

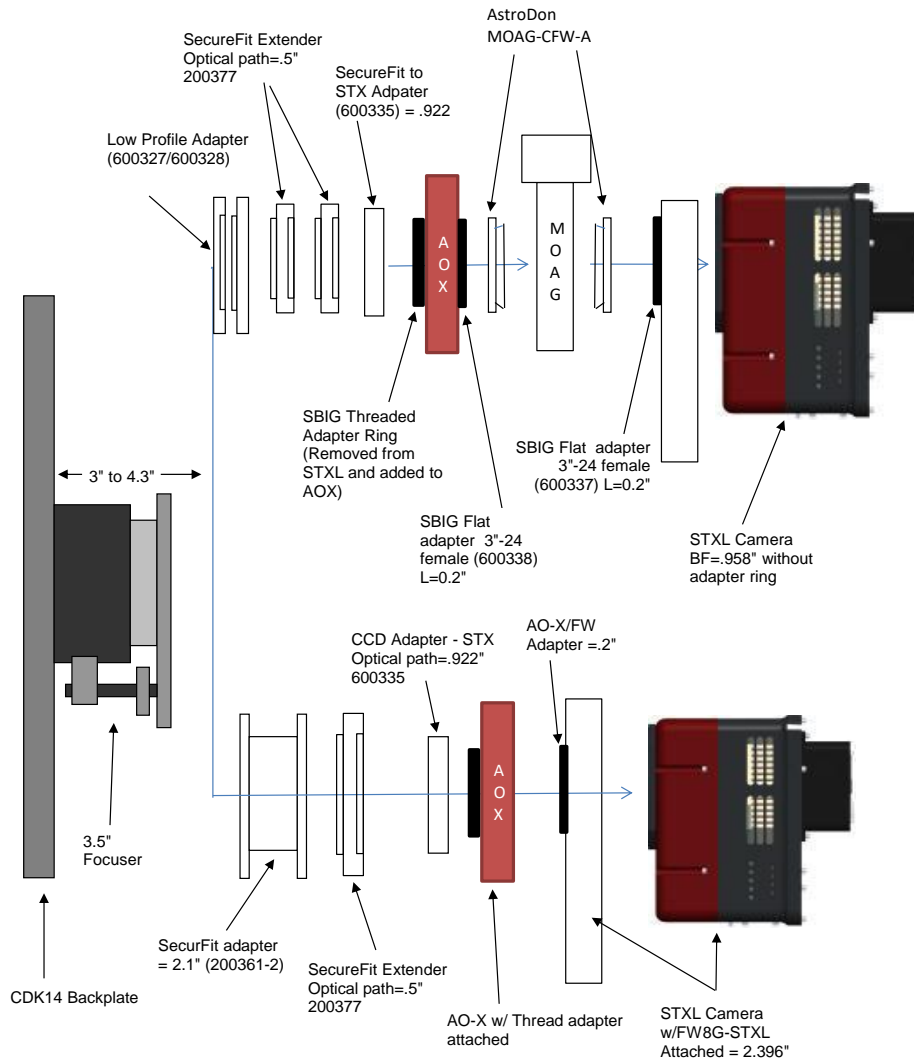

STXL camera w standard FW and MMOAG		11.09 remaining BF
Focuser racked in	3	8.09
Focuser position (0-1.3")	0.72	7.37
Low Profile Adapters - (600327/328)	0.5	6.87
SecureFit Extender - 200377	0.5	6.37
SecureFit Extender - 200377	0.5	5.87
CCD Adapter STX - 600335	0.922	4.95
AO-X	1.18	3.77
SBIG Flat Adapter (3"-24 female) - 600338	0.2	3.57
AstroDon MOAG-CFW-A	0.2	3.37
AstroDon - MMOAG	1.25	2.12
AstroDon MOAG-CFW-A	0.2	1.92
SBIG Flat Adapter (3"-24 female) - 600337	0.2	1.72
STXL w/filter wheel FW8S-STXL	1.723	0.00

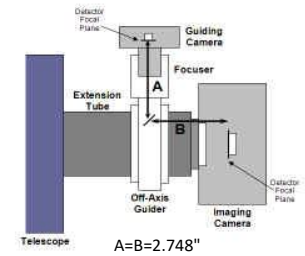

STXL w/ Self Guiding FW		11.09 remaining BF
Focuser racked in	3	8.09
Focuser position (0-1.3")	0.592	7.498
SecureFit CCD Spacer - 200361-2	2.1	5.398
SecureFit Extender - 200377	0.5	4.898
CCD Adapter STX - 600335	0.922	3.976
AO-X (w/ threaded adapter attached)	1.38	2.596
AO-X to FW adapter (SBIG)	0.2	2.396
STXL Camera w/FW8G-STXL Attached	2.396	0

PLANEWAVE INSTRUMENTS
CDK14 SPACERS FOR STXL CAMERAS

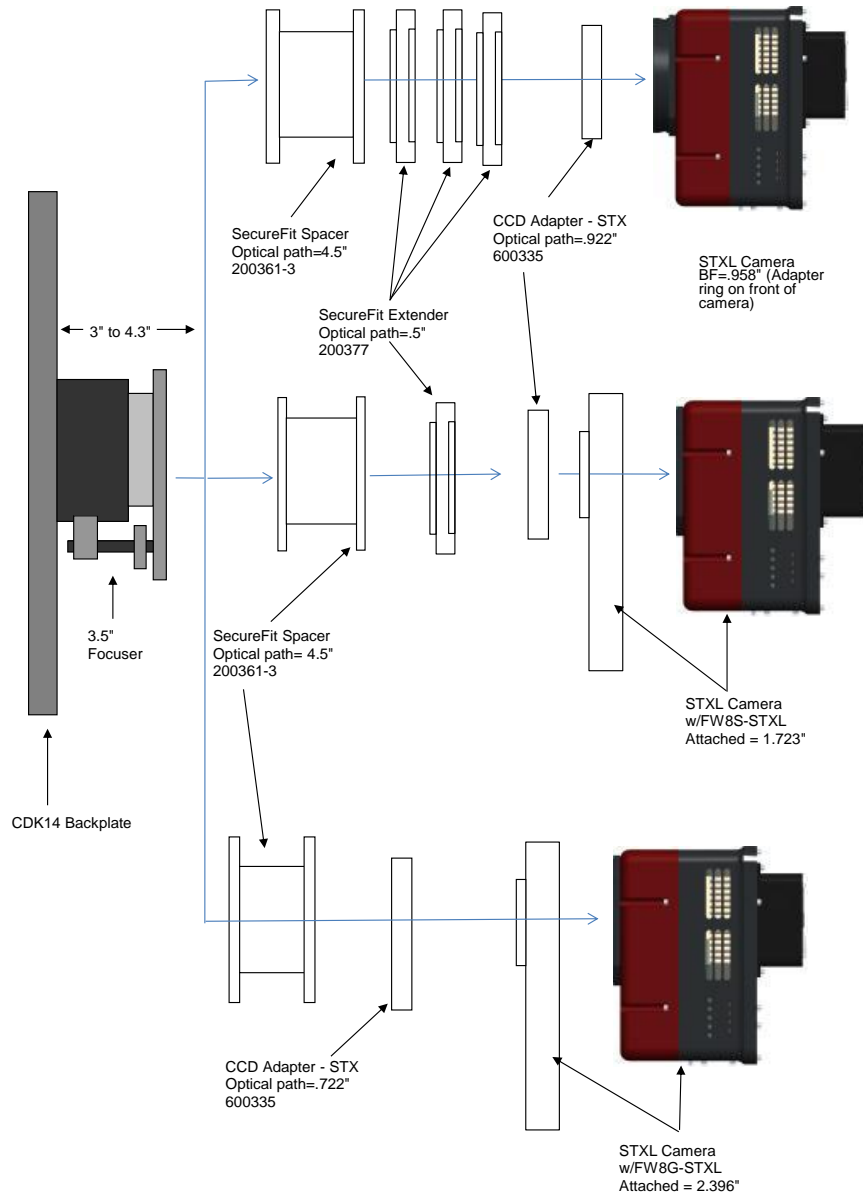

STXL	11.09	remaining BF
Focuser (200340) racked in	3	8.09
Focuser position (0-1.3")	0.21	7.88
SecureFit CCD Spacer - 200361-3	4.5	3.38
CCD SecureFit Extender - 200377	0.5	2.88
CCD SecureFit Extender - 200377	0.5	2.38
CCD SecureFit Extender - 200377	0.5	1.88
CCD Adapter STX - 600335	0.922	0.958
STXL Back Focus w/ threaded adapter ring attached	0.958	0

STXL w/ Standard FW	11.09	remaining BF
Focuser (200340) racked in	3	8.09
Focuser position (0-1.3")	0.645	7.445
SecureFit CCD Spacer - 200361-3	4.5	2.945
SecureFit Extender - 200377	0.5	2.445
CCD Adapter STX - 600335	0.722	1.723
STXL Camera w/FW8S-STXL Attached	1.723	0

STXL w/ Standard FW & IRF0	11.09	remaining BF
Focuser (600180) racked in	3.5	7.59
Focuser position (0-1.3")	0.345	7.245
SecureFit CCD Spacer - 200361-3	3.8	3.445
SecureFit Extender - 200377	0.5	2.945
SecureFit Extender - 200377	0.5	2.445
CCD Adapter STX - 600335	0.722	1.723
STXL Camera w/FW8S-STXL Attached	1.723	0

STXL w/ Self Guiding FW	11.09	remaining BF
Focuser racked in	3	8.09
Focuser position (0-1.3")	0.472	7.618
SecureFit CCD Spacer - 200361-3	4.5	3.118
CCD Adapter STX - 600335	0.722	2.396
STXL Camera w/FW8G-STXL Attached	2.396	0

STXL w/ Self Guiding FW & IRF90	11.09	remaining BF
Focuser (600180) racked in	3.5	7.59
Focuser position (0-1.3")	0.672	6.918
SecureFit CCD Spacer - 200361-1	3.8	3.118
CCD Adapter STX - 600335	0.722	2.396
STXL Camera w/FW8G-STXL Attached	2.396	0

CDK14- OPTICAL TRAIN: for SBIG STXL CAMERA & IMAGE ROTATORS

Distance to Focuser Mounting Surface 11.09

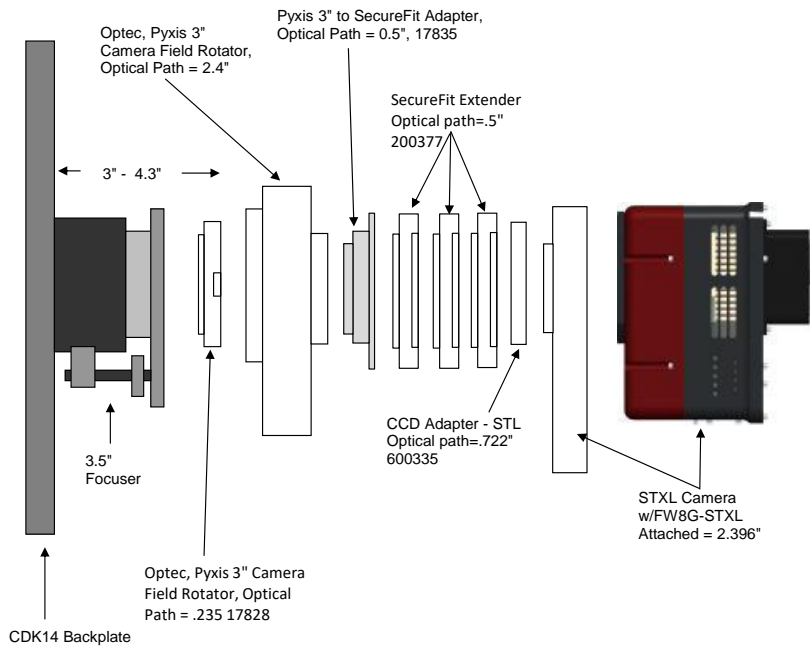

STXL, Self-Guiding FW, Pyxis	11.09	remaining BF
Focuser (racked in)	3	8.09
Focus position (0 to 1.3")	0.337	7.753
PW 14/17/20 to Optec-3600 dovetail adapter - 17828	0.235	7.518
Optec Pyxis 3" Camera Rotator	2.4	5.118
Optec Pyxis 3" to SecureFit Adapter - 17835	0.5	4.618
SecureFit Spacer (200377)	0.5	4.118
SecureFit Spacer (200377)	0.5	3.618
SecureFit Spacer (200377)	0.5	3.118
CCD Adapter STX - 600335	0.722	2.396
STXL Camera w/FW8G-STXL Attached	2.396	0

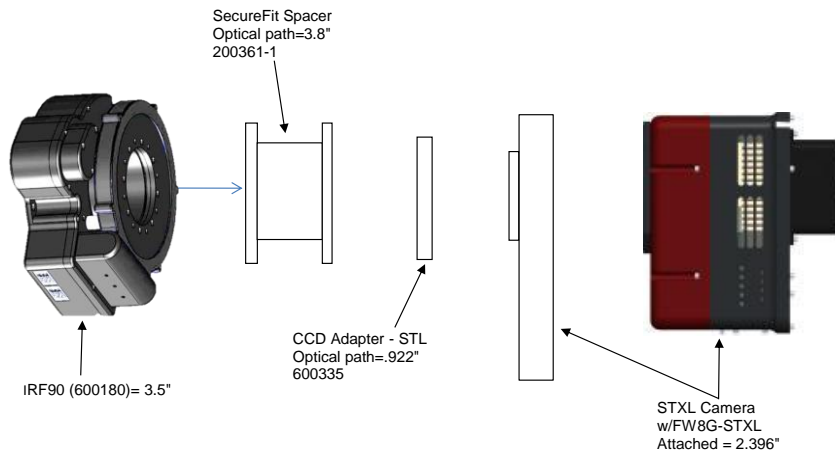

STXL, Self-Guiding FW, IRF90	11.09	remaining BF
IRF90 (600180)	3.5	7.59
Focus position (0 to 1.3")	0.472	7.118
SecureFit adapter 200361-1	3.8	3.318
CCD Adapter STX - 600335	0.922	2.396
STXL Camera w/FW8G-STXL Attached	2.396	0

PLANEWAVE INSTRUMENTS
SECUREFIT CCD SPACERS FOR STL CAMERAS
for CDK14

← 11.09 →
Distance from focuser mounting surface to focal plane

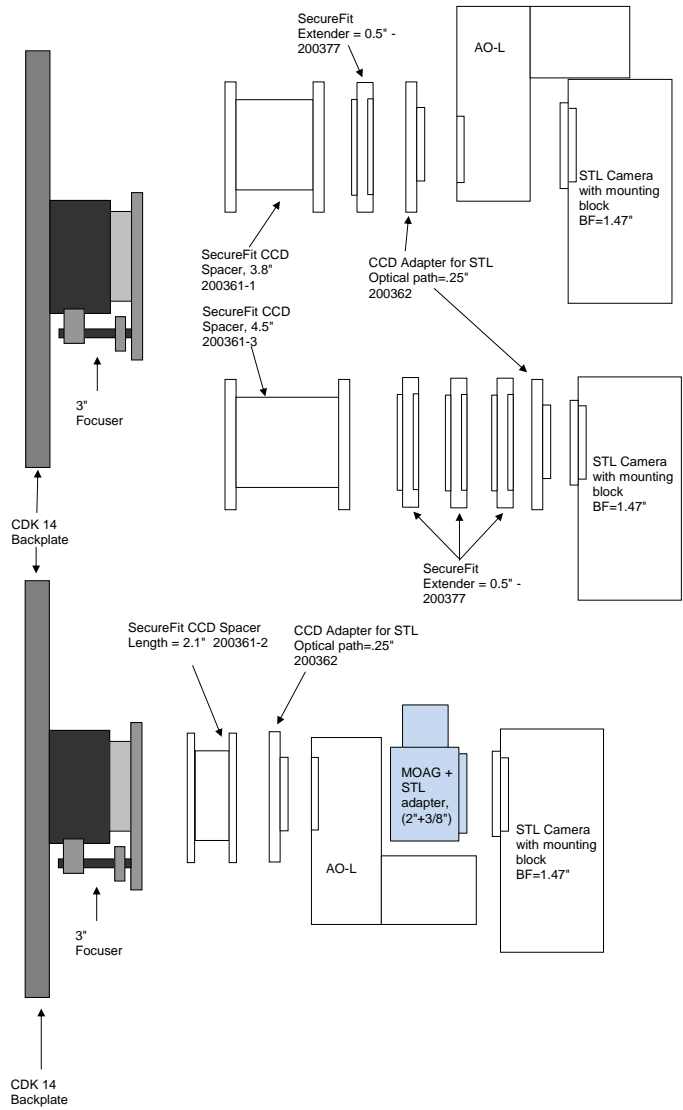

STL and AO-L required spacers	11.09	remaining BF
Focuser (racked in)	3	8.09
Focus position (0 to 1.3")	0.58	7.51
SecureFit CCD Spacer 3." - 200361-1	3.8	3.71
SecureFit Extender - 200377	0.5	3.21
CCD Adapter, STL - 200362	0.25	2.96
AO-L	1.49	1.47
STL Back Focus	1.47	0

STL Camera	11.09	remaining BF
Focuser (racked in)	3	8.09
Focus position (0 to 1.3")	0.37	7.72
SecureFit CCD Spacer 4.5" - 200361-3	4.5	3.22
SecureFit Extender - 200377	0.5	2.72
SecureFit Extender - 200377	0.5	2.22
SecureFit Extender - 200377	0.5	1.72
CCD Adapter, STL - 200362	0.25	1.47
STL Back Focus	1.47	0

STL, AO-L and MOAG	11.09	remaining BF
Focuser (racked in)	3	8.09
Focus position (0 to 1.3")	0.366	7.724
SecureFit CCD Spacer - 200361-2	2.1	5.624
CCD Adapter, STL - 200362	0.25	5.374
AO-L	1.49	3.884
MOAG from Astrodon (2" of backfocus)	2	1.884
MOAG to SLT Adapter (3/8")	0.375	1.509
STL Back Focus	1.509	0

PLANEWAVE INSTRUMENTS
SECUREFIT CCD SPACERS FOR STL CAMERAS
 for CDK14

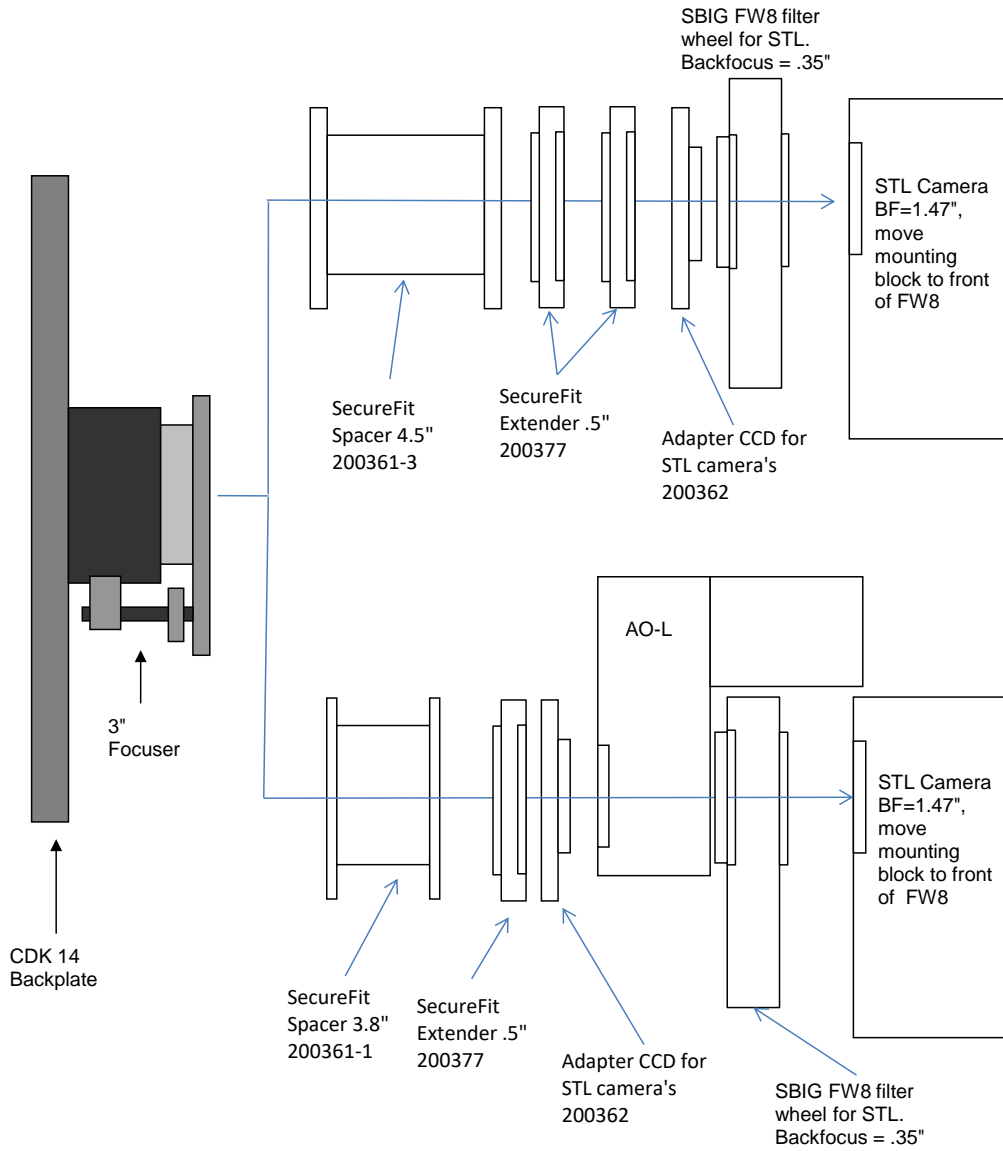

STL w/ FW8		11.09 remaining BF
Focuser racked in	3	8.09
Focus position (0 to 1.3")	0.52	7.57
SecureFit CCD Spacer 4.4" - 200361-3	4.5	3.07
SecureFit CCD Extender .5" - 200377	0.5	2.57
SecureFit CCD Extender .5" - 200377	0.5	2.07
CCD Adapter, STL - 200362	0.25	1.82
FW8	0.35	1.47
SLT Back Focus	1.47	0

STL + FW8 + AO-L		11.09 remaining BF
Focuser racked in	3	8.09
Focus position (0 to 1.3")	0.23	7.86
SecureFit CCD Spacer 3.8" - 200361-1	3.8	4.06
SecureFit CCD Extender .5" - 200377	0.5	3.56
CCD Adapter, STL - 200362	0.25	3.31
AO-L	1.49	1.82
FW8	0.35	1.47
SLT Back Focus	1.47	0

PLANEWAVE INSTRUMENTS
SECUREFIT CCD SPACERS FOR STL CAMERAS
 for CDK14

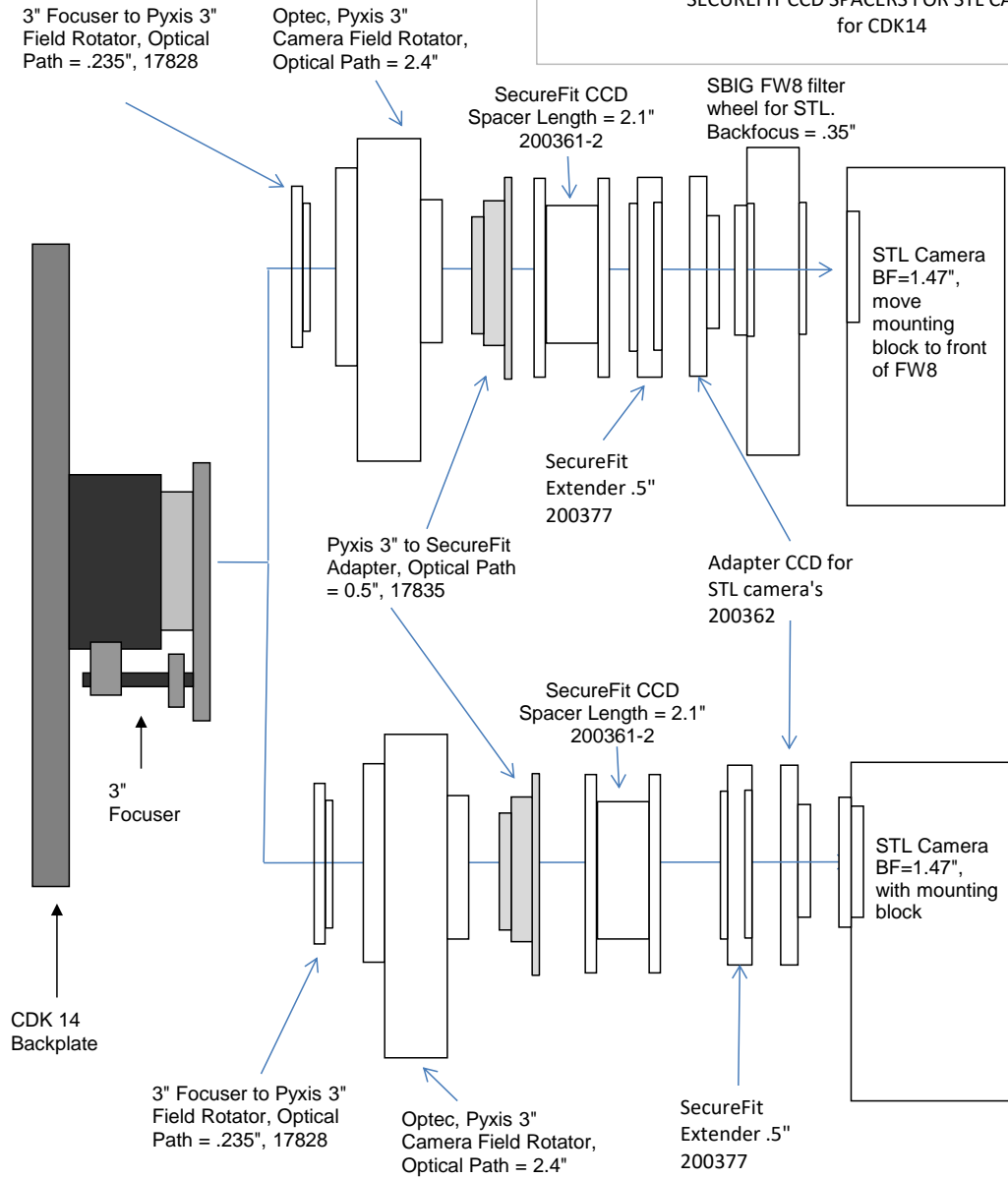

STL w/ FW8		11.09 remaining BF
Focuser racked in	3	8.09
Focus position (0 to 1.3")	0.285	7.805
3" Focuser to Pyxis Rotator - 17828	0.235	7.57
Optec Pyxis 3" Rotator - PYXIS 3	2.4	5.17
Pyxis Rotator to SecureFit - 17835	0.5	4.67
SecureFit CCD Adapter - 200361-2	2.1	2.57
Securefit Extender - 200377	0.5	2.07
CCD Adapter, STL - 200362	0.25	1.82
FW8	0.35	1.47
SLT Back Focus	1.47	0

STL + Pyxis		11.09 remaining BF
Focuser racked in	3	8.09
Focus position (0 to 1.3")	0.635	7.455
3" Focuser to Pyxis Rotator - 17828	0.235	7.22
Optec Pyxis 3" Rotator - PYXIS 3	2.4	4.82
Pyxis Rotator to SecureFit - 17835	0.5	4.32
SecureFit CCD Adapter - 200361-2	2.1	2.22
SecureFit CCD Extender .5" - 200377	0.5	1.72
CCD Adapter, STL - 200362	0.25	1.47
SLT Back Focus	1.47	0

CDK14 - OPTICAL TRAIN: for SBIG STL BODY, AND MMOAG

Distance to Focuser Mounting Surface 11.09

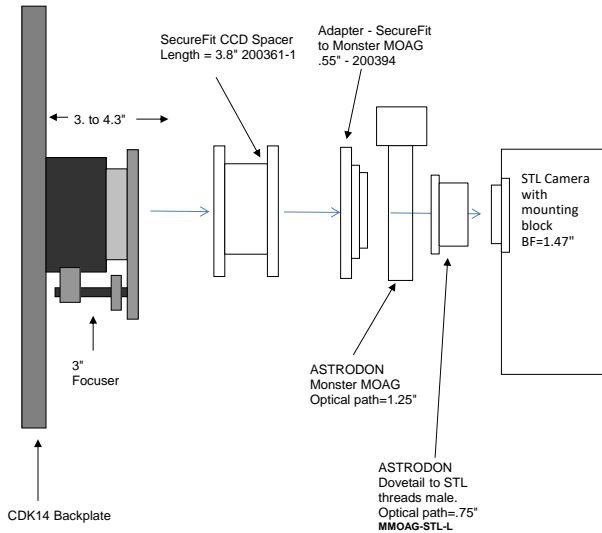

STL CCD & MMOAG	11.09	remaining BF
Focuser (racked in)	3	8.09
Focus position (0 to 1.3")	0.27	7.82
SecureFit CCD Spacer - 200361-1	3.8	4.02
Adapter SecureFit to Monster MOAG - 200394	0.55	3.47
Monster MOAG - MMOAG	1.25	2.22
AstroDon Adapter - MMOAG-STL-L	0.75	1.47
SBIG STL Camera with mounting block	1.47	0

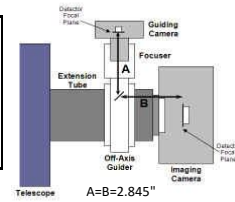

STL CCD, FW8 FILTER WHEEL & MMOAG	11.09	remaining BF
Focuser (racked in)	3	8.09
Focus position (0 to 1.3")	0.57	7.52
SecureFit CCD Spacer - 200361-2	3.8	3.72
Adapter SecureFit to Monster MOAG - 200394	0.55	3.17
Monster MOAG - MMOAG	1.25	1.92
AstroDon Adapter - MMOAG-STL-S	0.1	1.82
SBIG FW8 Filter Wheel	0.35	1.47
SBIG STL Camera with mounting block	1.47	0

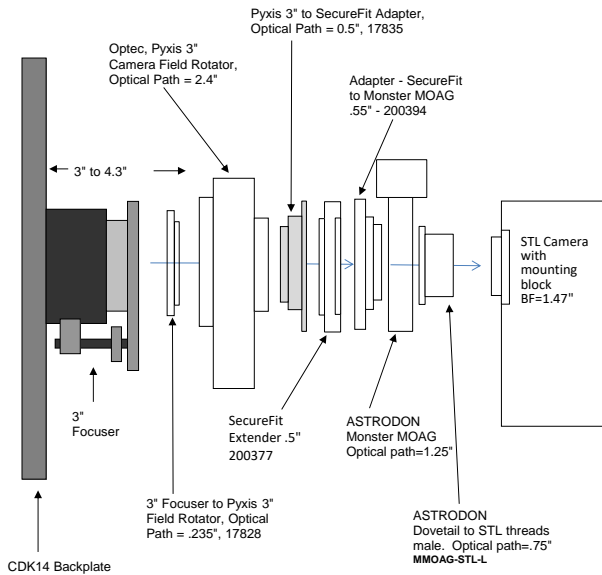
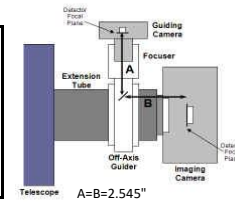

STL CCD, Pyxis & MMOAG	11.09	remaining BF
Focuser (racked in)	3	8.09
Focus position (0 to 1.3")	0.435	7.655
3" Focuser to Pyxis Rotator - 17828	0.235	7.42
Optec Pyxis 3" Camera Rotator	2.4	5.02
Optec Pyxis 3" to SecureFit Adapter - 17835	0.5	4.52
SecureFit Extender - 200377	0.5	4.02
Adapter SecureFit to Monster MOAG - 200394	0.55	3.47
Monster MOAG - MMOAG	1.25	2.22
AstroDon Adapter - MMOAG-STL-L	0.75	1.47
SBIG STL Camera with mounting block	1.47	0

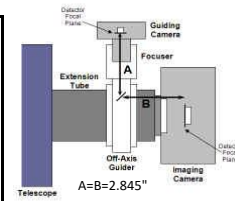

STL CCD, FW8, Pyxis & MMOAG	11.09	remaining BF
Focuser (racked in)	3	8.09
Focus position (0 to 1.3")	0.735	7.355
3" Focuser to Pyxis Rotator - 17828	0.235	7.12
Optec Pyxis 3" Camera Rotator	2.4	4.72
Optec Pyxis 3" to SecureFit Adapter - 17835	0.5	4.22
SecureFit Extender - 200377	0.5	3.72
Adapter SecureFit to Monster MOAG - 200394	0.55	3.17
Monster MOAG - MMOAG	1.25	1.92
AstroDon Adapter - MMOAG-STL-S	0.1	1.82
SBIG FW8 Filter Wheel	0.35	1.47
SBIG STL Camera with mounting block	1.47	0

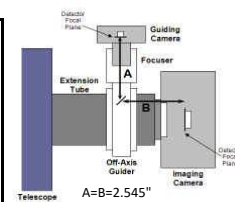

PLANEWAVE INSTRUMENTS
CDK14 SECUREFIT CCD SPACERS FOR ST CAMERAS

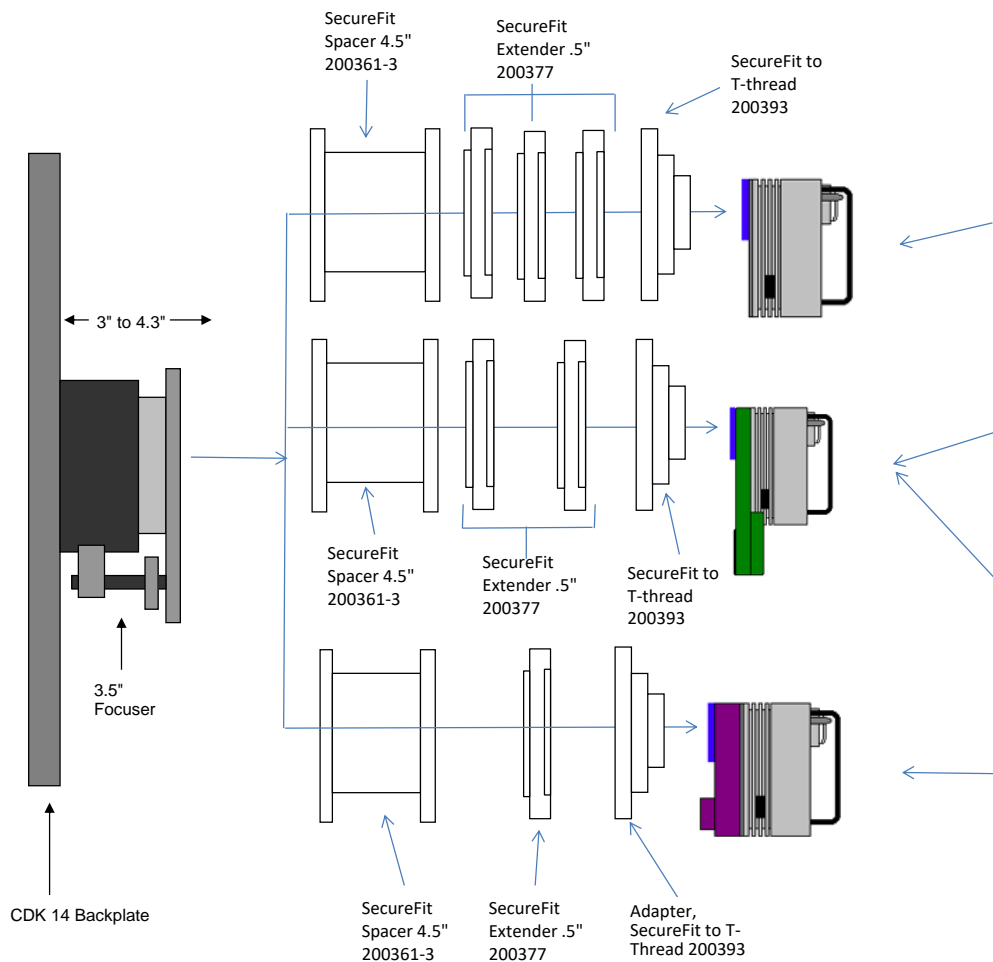

SecureFit w/ ST		11.09 remaining BF
Focuser racked in	3	8.09
Focuser Position (0 - 1.3")	0.528	7.562
SecureFit 4.5 - 200361-3	4.5	3.062
CCD SecureFit Extender - 200377	0.5	2.562
CCD SecureFit Extender - 200377	0.5	2.062
CCD SecureFit Extender - 200377	0.5	1.562
Adapter, SecureFit to T thread - 200393	0.55	1.012
ST Back Focus (with D-block)	1.012	0

SecureFit with ST and CFW10		11.09 remaining BF
Focuser racked in	3	8.09
Focuser Position (0 - 1.3")	0.448	7.642
SecureFit 4.5 - 200361-3	4.5	3.142
SecureFit Extender - 200377	0.5	2.642
SecureFit Extender - 200377	0.5	2.142
Adapter, SecureFit to T thread - 200393	0.55	1.592
ST w/ CFW10 Back Focus (with D-block)	1.592	0

SecureFit with ST and CFW10SA		11.09 remaining BF
Focuser racked in	3	8.09
Focuser Position (0 - 1.3")	0.73	7.36
SecureFit 4.5 - 200361-3	4.5	2.86
SecureFit Extender - 200377	0.5	2.36
Adapter, SecureFit to T thread - 200393	0.55	1.81
ST w/ CFW10 Back Focus, (w/ D-block)	1.81	0

SecureFit with ST and CFW8		11.09 remaining BF
Focuser racked in	3	8.09
Focuser Position (0 - 1.3")	0.528	7.562
SecureFit 4.5 - 200361-3	4.5	3.062
SecureFit Extender - 200377	0.5	2.562
Adapter, SecureFit to T thread - 200393	0.55	2.012
ST w/ CFW8 Back Focus, (w/ D-block)	2.012	0

PLANEWAVE INSTRUMENTS
CDK14 SECUREFIT CCD SPACERS FOR ST CAMERAS

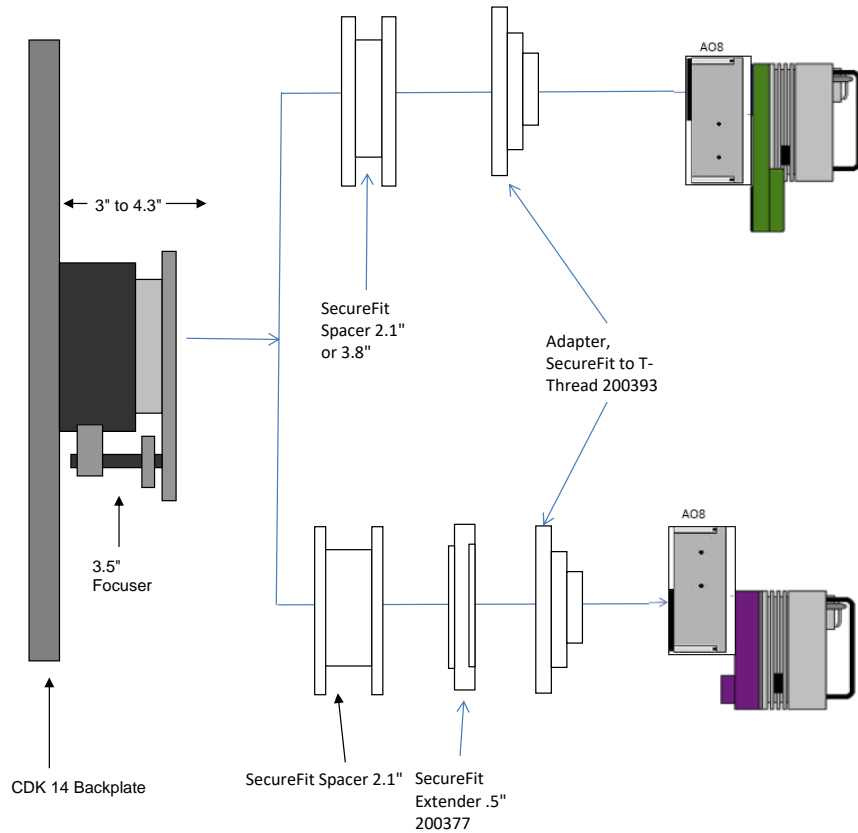

SecureFit with ST, CFW10, & AO-8	11.09 remaining BF	
Focuser racked in	3	8.09
Focuser Position (0 - 1.3")	0.248	7.842
SecureFit Spacer 2.1 - 200361-2	3.8	4.042
Adapter, SecureFit to T thread - 200393	0.55	3.492
AO-8, 1.9" of backfocus + .27 for D-block	2.17	1.322
ST w/ CFW10 Back Focus (w/o D-block)	1.322	0

SecureFit with ST and CFW10SA	11.09 remaining BF	
Focuser racked in	3	8.09
Focuser Position (0 - 1.3")	0.73	7.36
SecureFit Spacer 4.5 - 200361-3	4.5	2.86
SecureFit Extender - 200377	0.5	2.36
Adapter, SecureFit to T thread - 200393	0.55	1.81
ST w/ CFW10 Back Focus, (w/ D-block)	1.81	0

SecureFit with ST, CFW8, & AO-8	11.09 remaining BF	
Focuser racked in	3	8.09
Focuser Position (0 - 1.3")	0.758	7.332
SecureFit Spacer 2.1 - 200361-2	2.1	5.232
SecureFit Extender - 200377	0.5	4.732
Adapter, SecureFit to T thread - 200393	0.55	4.182
AO-8, 1.9" of backfocus + .27 for D-block	2.17	2.012
ST w/ CFW8 Back Focus, (w/ D-block)	2.012	0

SecureFit with STT w/Self Guiding FW & AO-8T	11.09 remaining BF	
Focuser racked in - 200340	3	8.09
Focus position	0.721	7.369
SecureFit - 200361-2	2.1	5.269
Securefit extender - 200377	0.5	4.769
T-thread adapter - 200393	0.55	4.219
AO-8T w/t-thread adapter plate	2.091	2.128
FW8G-STT attached to STT camera	2.128	0

PLANEWAVE INSTRUMENTS
CDK14 SECUREFIT SPACERS FOR ST8300/STT-1603ME CAMERAS

Distance to Focuser Mounting Surface

11.09

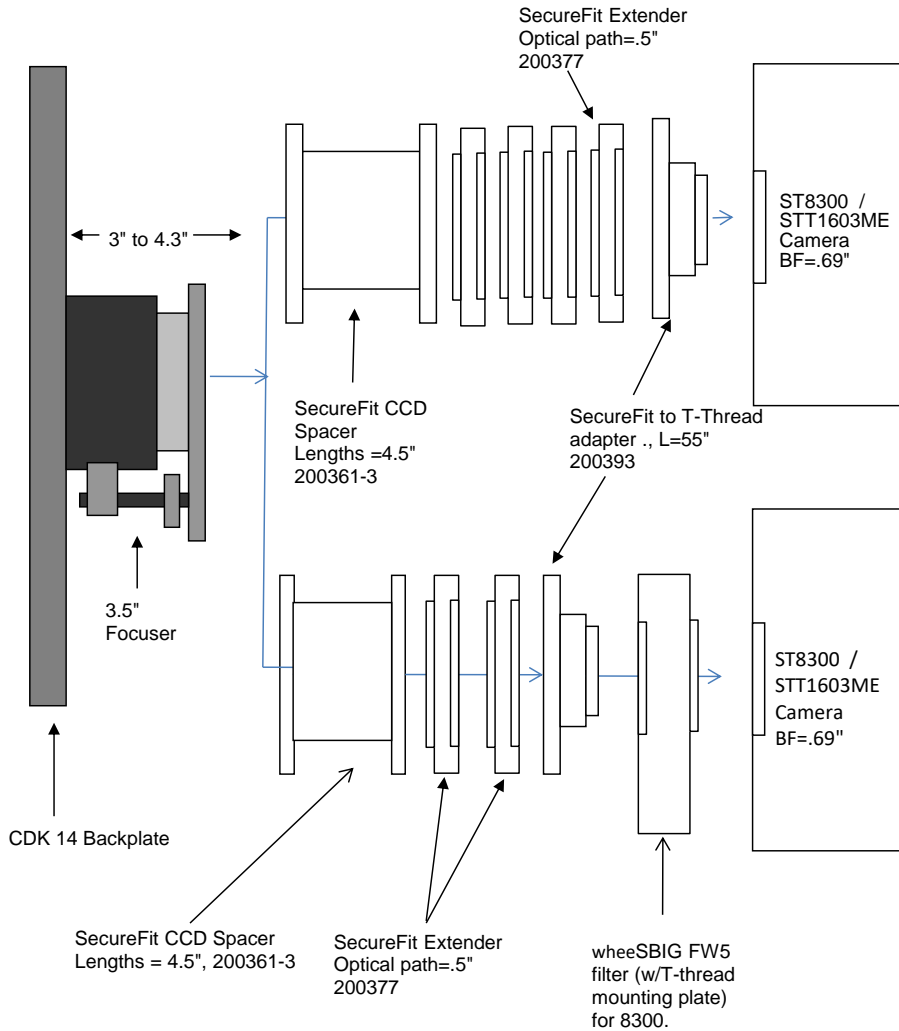

ST8300 Camera Alone		11.09 remaining BF
Focuser racked in	3	8.09
Focuser position (0-1.3")	0.35	7.74
CCD Spacer 4.5- 200361-3	4.5	3.24
CCD SecureFit Extender - 200377	0.5	2.74
CCD SecureFit Extender - 200377	0.5	2.24
CCD SecureFit Extender - 200377	0.5	1.74
CCD SecureFit Extender - 200377	0.5	1.24
SecureFit to T-Thread - 200393	0.55	0.69
STT Back Focus	0.69	0

ST8300 Camera FW8 or FW5 for 8300		11.09 remaining BF
Focuser racked in	3	8.09
Focuser position (0-1.3")	0.56	7.53
CCD Spacer 3.8 - 200361-1	4.5	3.03
CCD SecureFit Extender - 200377	0.5	2.53
CCD SecureFit Extender - 200377	0.5	2.03
SecureFit to T-Thread - 200393	0.55	1.48
FW5 or 8 for 8300, Back Focus=.79"	0.79	0.69
STT Back Focus	0.69	0

PLANEWAVE INSTRUMENTS
CDK14 SECUREFIT SPACERS FOR STT CAMERAS

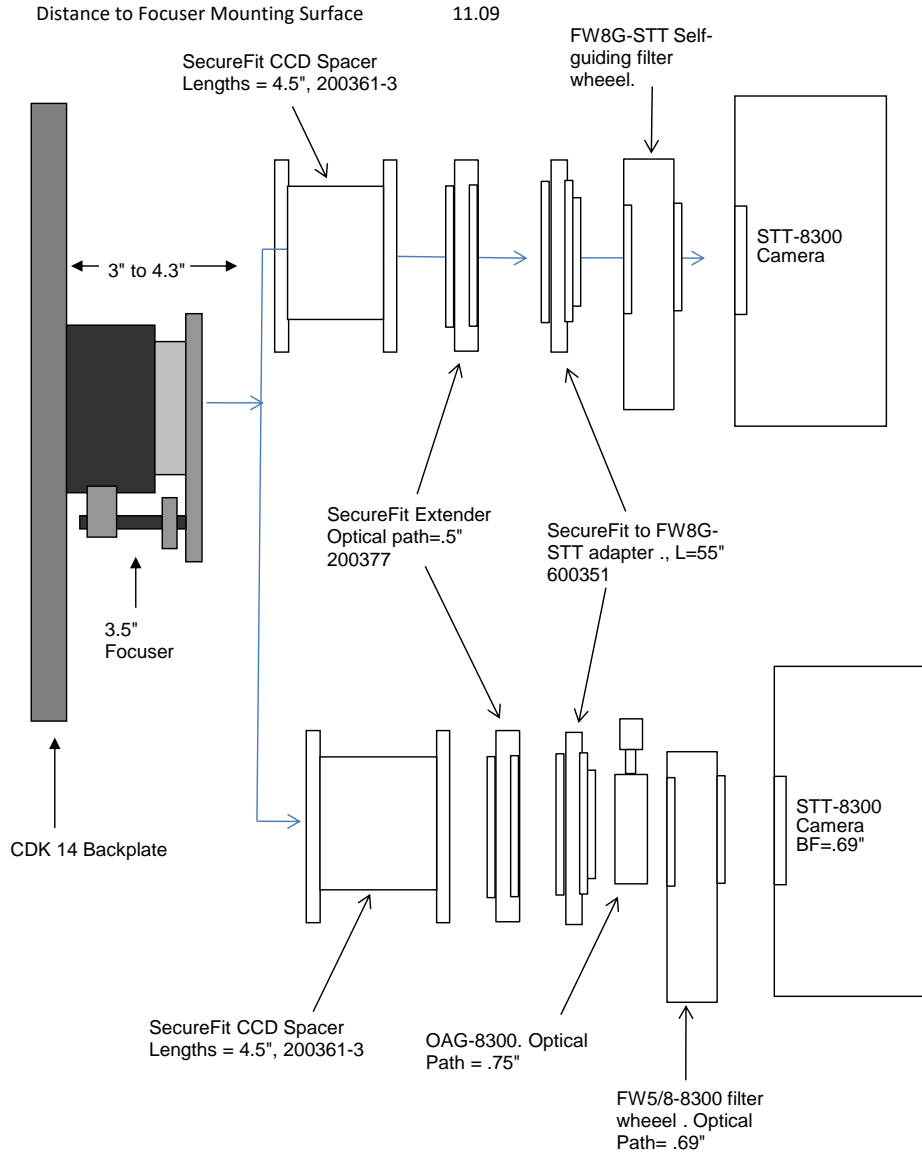

STT8300 Camera w/ Self Guiding Filter Wheel	11.09 remaining BF	
Focuser racked in	3	8.09
Focuser position (0-1.3")	0.412	7.678
SecureFit Spacer 4.5- 200361-3	4.5	3.178
CCD SecureFit Extender - 200377	0.5	2.678
SecureFit to FW8G-STT - 600351	0.55	2.128
FW8G-SST attached to STT-8300 Camera	2.128	0

STT8300 Camera w/Filter Wheel, OAG8300	11.09 remaining BF	
Focuser racked in	3	8.09
Focuser position (0-1.3")	0.31	7.78
SecureFit Spacer 4.5- 200361-3	4.5	3.28
CCD SecureFit Extender - 200377	0.5	2.78
SecureFit to FW8G-STT - 600351	0.55	2.23
OAG-8300	0.75	1.48
FW5-8300 / FW8-8300	0.79	0.69
STT-8300 Camera	0.69	0

STT Camera, FW8G-STT, OA-8T	11.09 remaining BF	
Focuser racked in - 200340	3	8.09
Focus position	0.721	7.369
SecureFit - 200361-2	2.1	5.269
Securefit extender - 200377	0.5	4.769
T-thread adapter - 200393	0.55	4.219
AO-8T w/t-thread adapter plate	2.091	2.128
FW8G-STT attached to STT camera	2.128	0

PLANEWAVE INSTRUMENTS
CDK17 SPACERS FOR STX CAMERAS

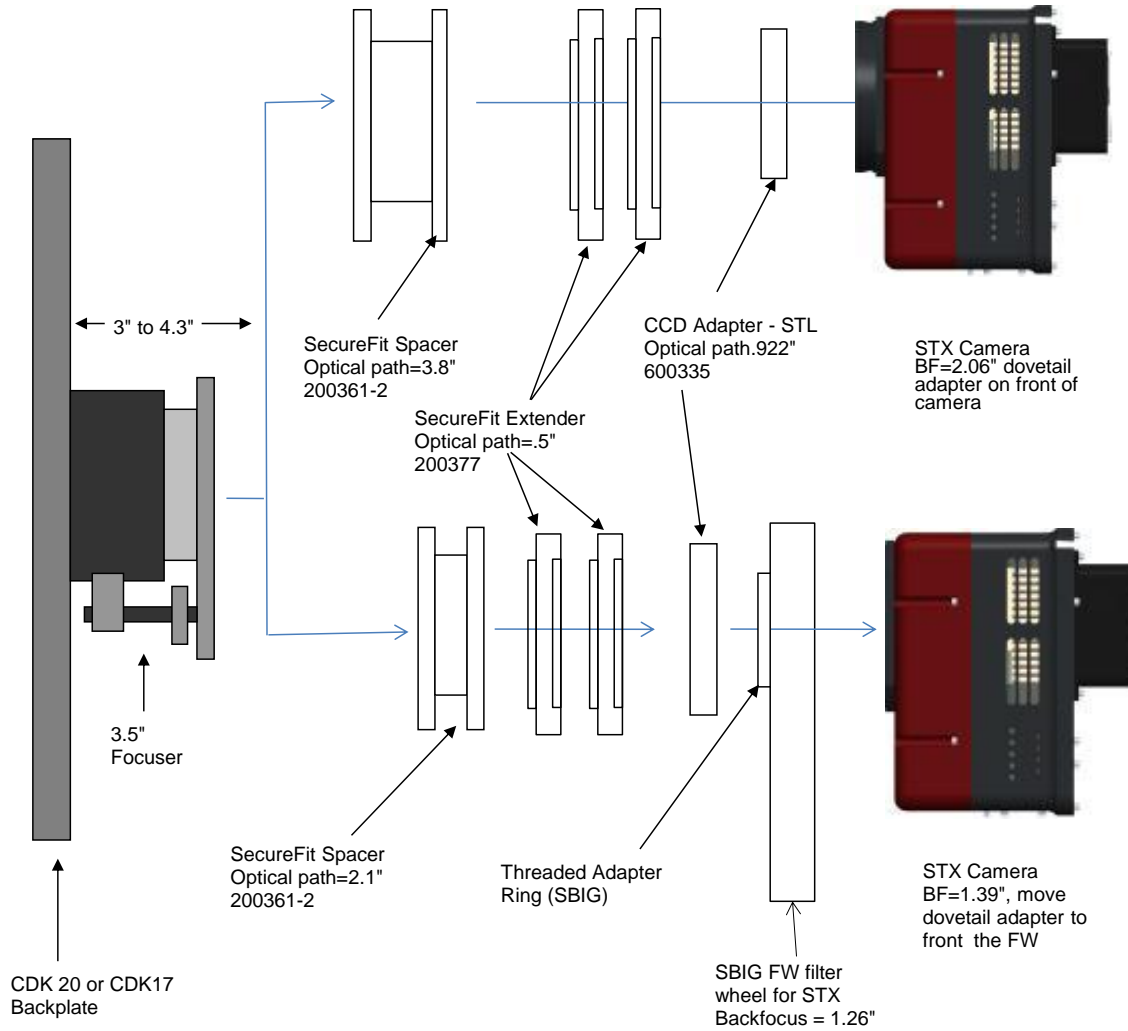

STX	10.24	remaining BF
Focuser racked in	3	7.24
Focuser position (0-1.3") 200340	0.628	6.612
CCD Spacer 3.8" - 200361-1	3.8	2.812
CCD SecureFit Extender - 200377	0.5	2.312
CCD Adapter STX - 600335	0.922	1.39
STX Back Focus w/threaded adapter ring attached	1.39	0

STX w/ IRF90	10.24	remaining BF
IR90 (raked in) 600180	3.5	6.74
Focus Position (0-1.3")	0.628	6.112
SecureFit 3.8" Adapter - 200361-1	3.8	2.312
CCD Adapter STX - 600335	0.922	1.39
SBIG STX 16803	1.39	0

STX w/ FW	10.24	remaining BF
Focuser racked in	3	7.24
Focuser position (0-1.3")	0.568	6.672
CCD Spacer 2.1 - 200361-2	2.1	4.572
SecureFit Extender - 200377	0.5	4.072
SecureFit Extender - 200377	0.5	3.572
CCD Adapter STX - 600335	0.922	2.65
Filter Wheel w/threaded adapter ring attached	1.26	1.39
STX Back Focus	1.39	0

PLANEWAVE INSTRUMENTS
CDK17 SPACERS FOR STX CAMERAS

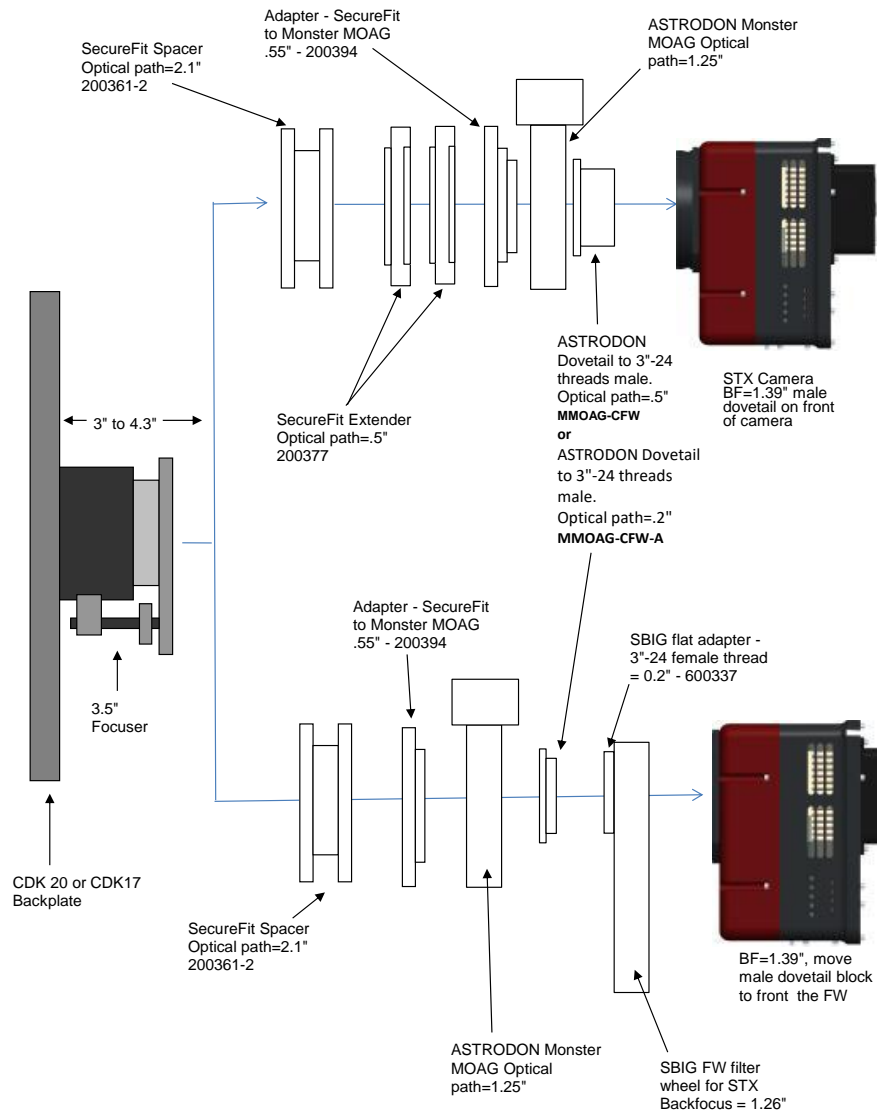

STX camera and MMOAG		10.24 remaining BF
Focuser racked in	3	7.24
Focuser position (0-1.3\"/>	0.7	6.54
CCD Spacer 2.1 - 200361-2	2.1	4.44
SecureFit 1/2\"/> Spacer - 200377	0.5	3.94
CCD SecureFit to MMOAG - 200394	0.55	3.39
Monster MOAG	1.25	2.14
MMOAG-STL-L	0.75	1.39
STX Back Focus	1.39	0

STX camera and MMOAG		10.24 remaining BF
Focuser racked in	3	7.24
Focuser position (0-1.3\"/>	0.45	6.79
CCD Spacer 2.1 - 200361-2	2.1	4.69
SecureFit 1/2\"/> Spacer - 200377	0.5	4.19
SecureFit 1/2\"/> Spacer - 200377	0.5	3.69
CCD SecureFit to MMOAG - 200394	0.55	3.14
Monster MOAG	1.25	1.89
MMOAG-CFW	0.5	1.39
SLT Back Focus	1.39	0

STX camera and MMOAG		10.24 remaining BF
Focuser racked in	3	7.24
Focuser position (0-1.3\"/>	0.29	6.95
CCD Spacer 2.1 - 200361-2	2.1	4.85
CCD SecureFit to MMOAG - 200394	0.55	4.3
AstroDon part - MMOAG	1.25	3.05
AstroDon part - MMOAG-CFW-A	0.2	2.85
SBIG Flat Adapter - 600337	0.2	2.65
Filter Wheel, FW8	1.26	1.39
SLX Back Focus	1.39	0

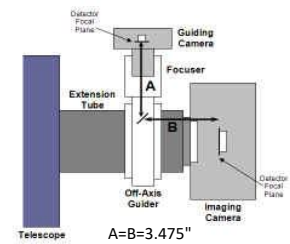
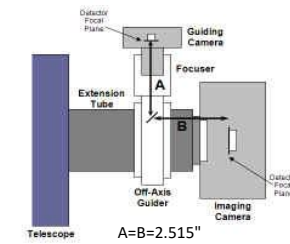
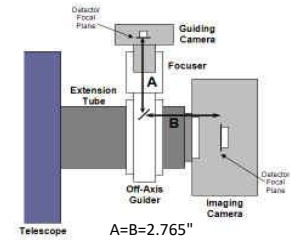

PLANEWAVE INSTRUMENTS
CDK17 SPACERS FOR STX CAMERAS

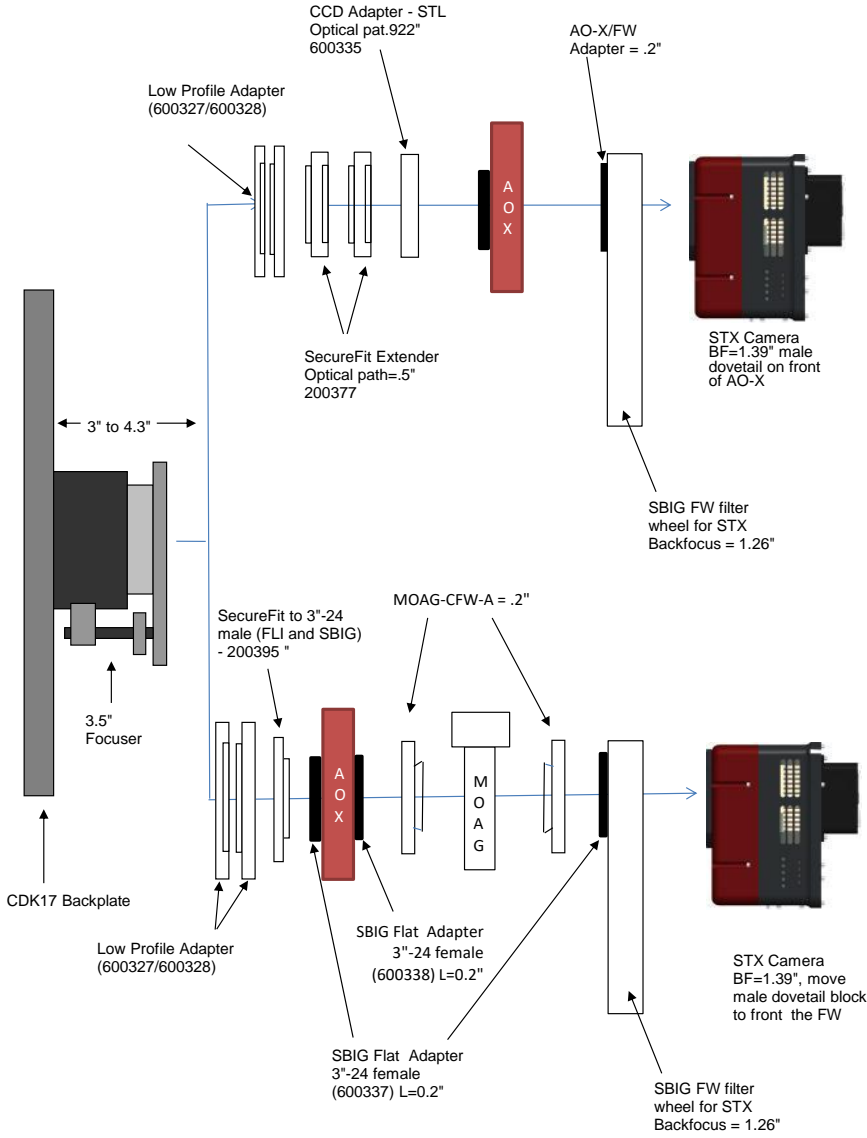

STX camera, AO-X, CFW		10.24 remaining BF
Focuser racked in	3	7.24
Focuser position (0-1.3")	0.588	6.652
Low Profile Adapter - (600327/328)	0.5	6.152
SecureFit 1/2" Spacer - 200377	0.5	5.652
SecureFit 1/2" Spacer - 200377	0.5	5.152
CCD SecureFit to STL - 600335	0.922	4.23
AO-X (w/ threaded adapter attached)	1.38	2.85
AO-X to FW adapter (SBIG)	0.2	2.65
SBIG Filter Wheel (w/.2" adapter)	1.26	1.39
STX Back Focus	1.39	0

STX camera and MMOAG		10.24 remaining BF
Focuser racked in	3	7.24
Focuser position (0-1.3")	0.41	6.83
Low profile adapters- 600327/328	0.5	6.33
SecureFit to 3"-24 male (FLI and SBIG) - 200395-3	0.25	6.08
SBIG Flat Adapter (3"-24 female) - 600337	0.2	5.88
AO-X	1.18	4.7
SBIG Flat Adapter (3"-24 female) - 600338	0.2	4.5
MOAG-CWF-A	0.2	4.3
AstroDon part - MMOAG	1.25	3.05
MOAG-CWF-A	0.2	2.85
SBIG Flat Adapter (3"-24 female) - 600337	0.2	2.65
Filter Wheel, FW8	1.26	1.39
STX Back Focus	1.39	0

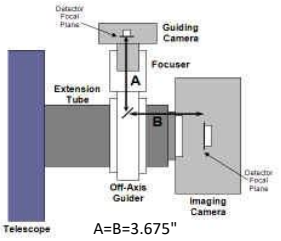

PLANEWAVE INSTRUMENTS
CDK17 SPACERS FOR STX CAMERAS with STX Guider

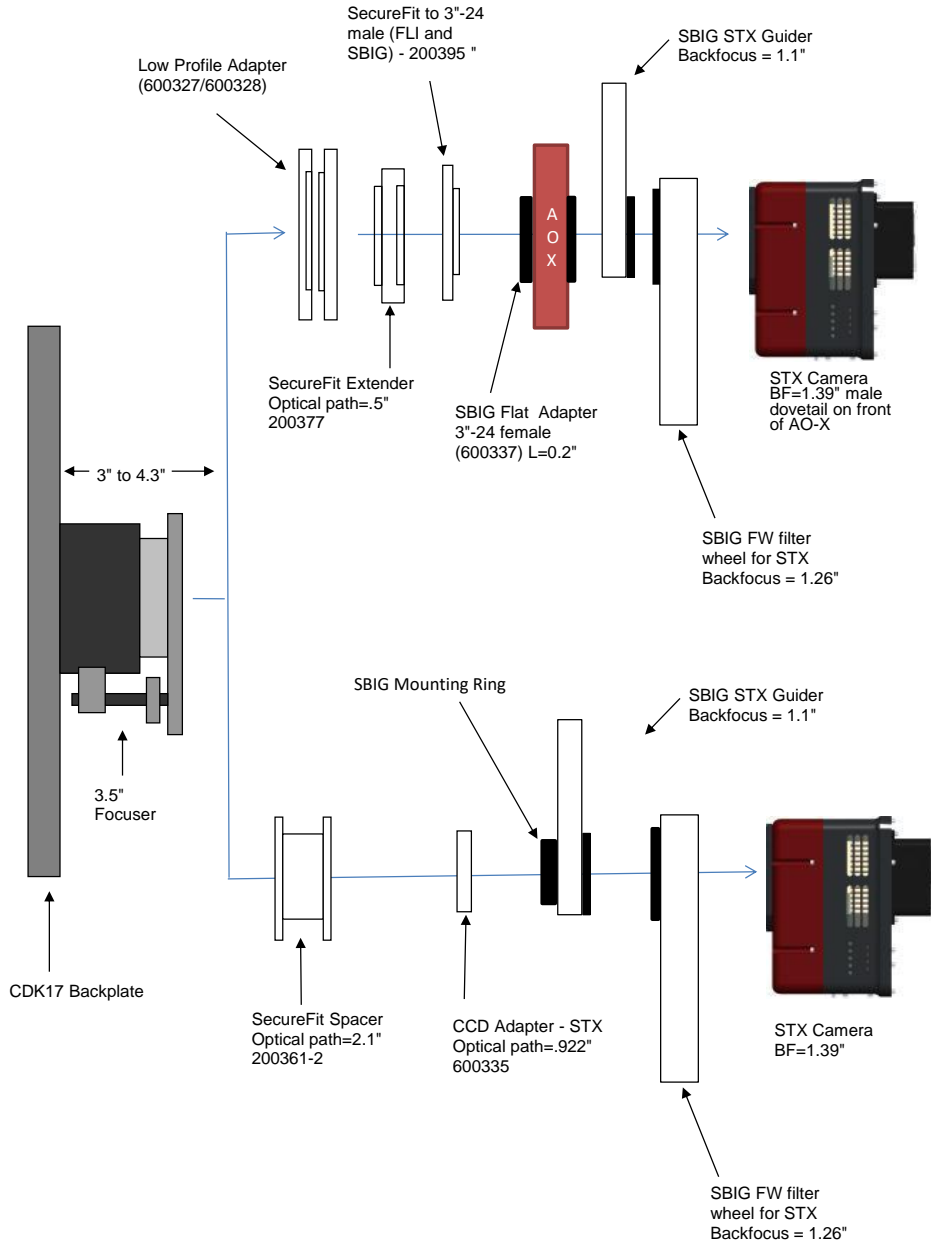

STX camera, AO-X, CFW, STX Guider		10.24 remaining BF
Focuser racked in	3	7.24
Focuser position (0-1.3")	0.66	6.58
Low Profile Adapter (focuser) - 600327	0.25	6.33
Low Profile Adapter (camera) - 600328	0.25	6.08
SecureFit Extender - 200377	0.5	5.58
CCD SecureFit 3-24 - 200395-3	0.25	5.33
SBIG Flat adaptet 3"-24 - 600337	0.2	5.13
AO-X	1.18	3.95
AO-X to FW adapter (SBIG)	0.2	3.75
STX Guider	1.1	2.65
SBIG Filter Wheel	1.26	1.39
STX Back Focus	1.39	0

STX camera, CFW, STX Guider		10.24 remaining BF
Focuser racked in	3	7.24
Focuser position (0-1.3")	0.468	6.772
SecureFit Adapter 2.1 - 200361-2	2.1	4.672
STX/STXL to SecureFit adapter - 600335	0.922	3.75
STX Guider w/camera mounting ring attached	1.1	2.65
SBIG Filter Wheel	1.26	1.39
STX Back Focus	1.39	0

STX camera, CFW, STX Guider w/ IRF90		10.24 remaining BF
IRF 90 racked in	3.5	6.74
Focuser position (0-1.3")	0.39	6.35
SecureFit Adapter 2.1 - 200361-2	2.1	4.25
SecureFit to 3"-24 male (FLI and SBIG) - 200395-3	0.25	4
SBIG Flat Adapter (3"-24 female) - 600337	0.25	3.75
STX Guider	1.1	2.65
SBIG Filter Wheel	1.26	1.39
STX Back Focus	1.39	0

PLANEWAVE INSTRUMENTS
CDK17 SPACERS FOR STXL CAMERAS

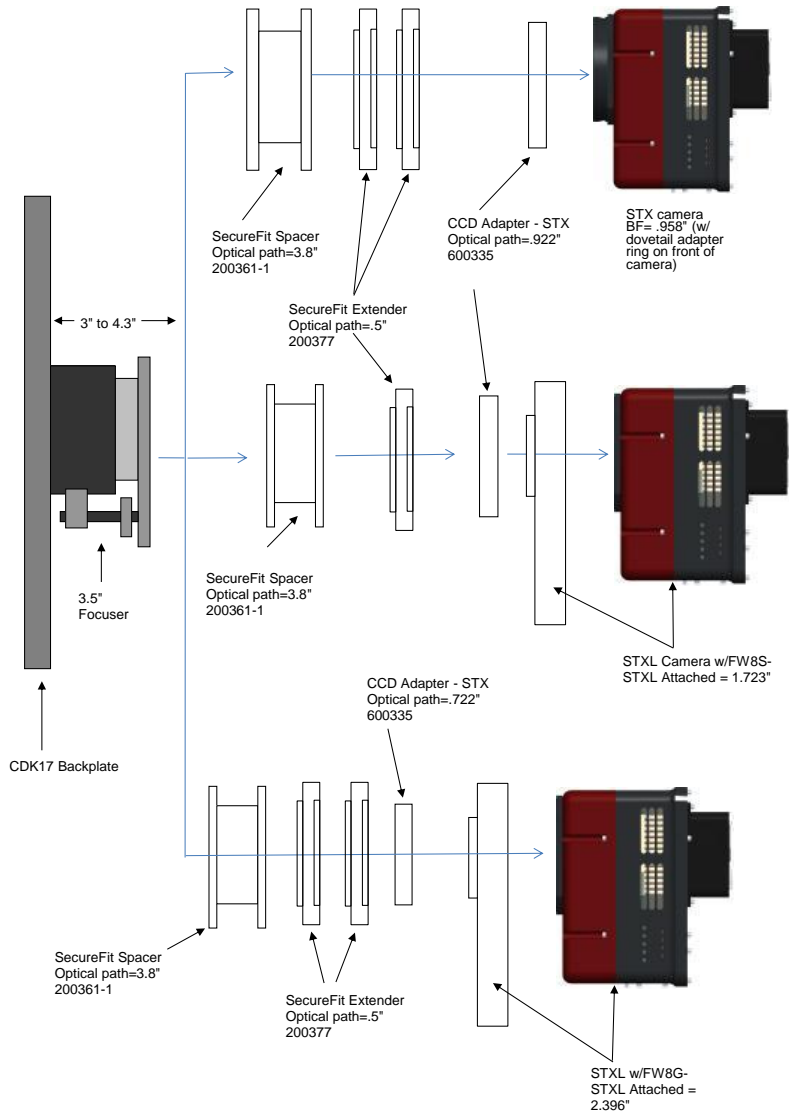

STXL	10.24 remaining BF	
Focuser (200340) racked in	3	7.24
Focuser position (0-1.3")	0.76	6.48
CCD Spacer 3.5" - 200361-1	3.8	2.68
CCD SecureFit Extender - 200377	0.5	2.18
CCD SecureFit Extender - 200377	0.5	1.68
CCD Adapter STX - 600335	0.722	0.958
STXL Back Focus w/threaded adapter ring attached	0.958	0

STXL & IRF90	10.24 remaining BF	
IRF90 - 600180	3.5	6.74
Focuser position (0-1.3")	0.56	6.18
CCD Spacer 3.5" - 200361-1	3.8	2.38
CCD SecureFit Extender - 200377	0.5	1.88
CCD Adapter STX - 600335	0.922	0.958
STXL Back Focus w/threaded adapter ring attached	0.958	0

STXL w/ Standard FW	10.24 remaining BF	
Focuser (200340) racked in	3	7.24
Focuser position (0-1.3")	0.495	6.745
SecureFit CCD Spacer - 200361-1	3.8	2.945
SecureFit Extender - 200377	0.5	2.445
CCD Adapter STX - 600335	0.722	1.723
STXL Camera w/FW8S-STXL Attached	1.723	0

STXL w/ Standard FW & IRF90	10.24 remaining BF	
Focuser (600180) racked in	3.5	6.74
Focuser position (0-1.3")	0.495	6.245
SecureFit CCD Spacer - 200361-1	3.8	2.445
CCD Adapter STX - 600335	0.722	1.723
STXL Camera w/FW8S-STXL Attached	1.723	0

STXL w/ Self Guiding FW	10.24 remaining BF	
Focuser (200340) racked in	3	7.24
Focuser position (0-1.3")	0.322	6.918
SecureFit CCD Spacer - 200361-1	3.8	3.118
CCD Adapter STX - 600335	0.722	2.396
STXL w/FW8G-STXL Attached	2.396	0

STXL w/ Self Guiding FW & IRF90	10.24 remaining BF	
Focuser (600180) racked in	3.5	6.74
Focuser position (0-1.3")	0.522	6.218
SecureFit CCD Spacer - 200361-2	2.1	4.118
SecureFit Extender - 200377	0.5	3.618
SecureFit Extender - 200377	0.5	3.118
CCD Adapter STX - 600335	0.722	2.396
STXL w/FW8G-STXL Attached	2.396	0

PLANEWAVE INSTRUMENTS
CDK17 SPACERS FOR STXL CAMERAS

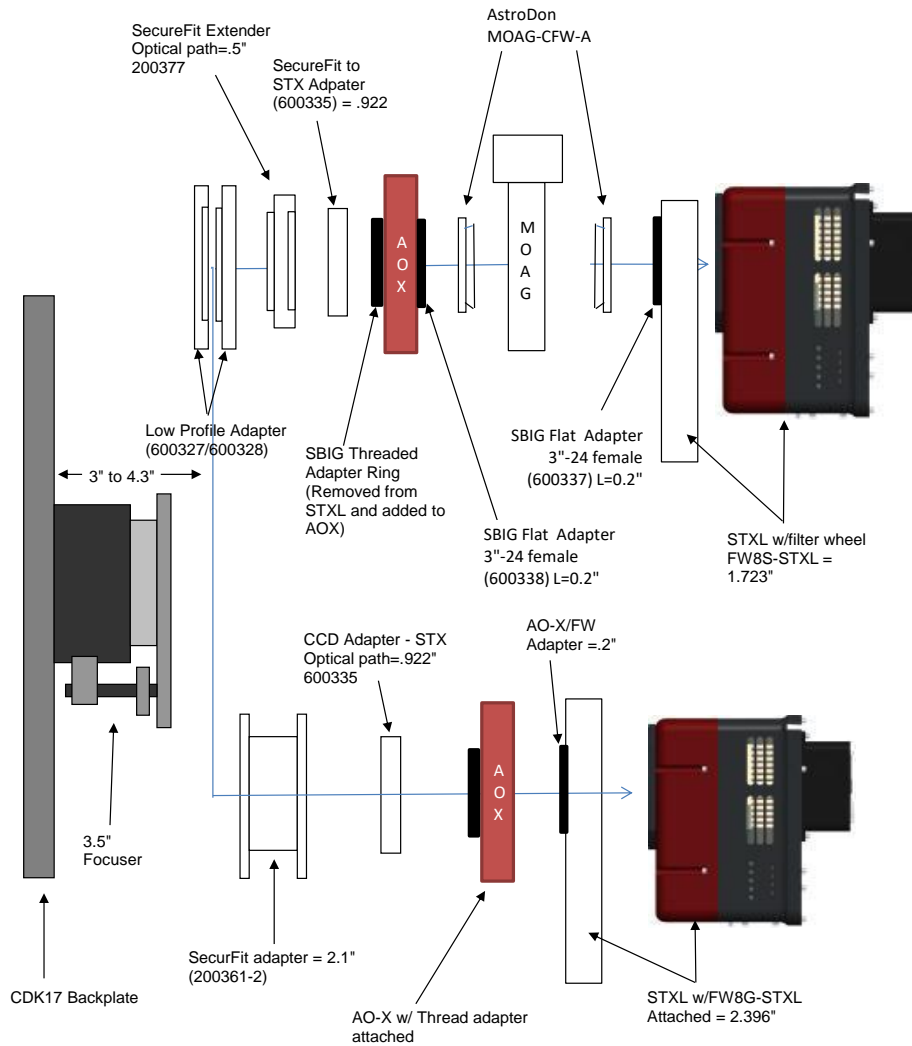

STXL camera w standard FW and MMOAG		10.24 remaining BF
Focuser racked in	3	7.24
Focuser position (0-1.3")	0.365	6.875
Low profile adapters- 600327/600328	0.5	6.375
SecureFit Extender - 200377	0.5	5.875
CCD Adapter STX - 600335	0.922	4.953
AO-X	1.18	3.773
SBIG Flat Adapter (3"-24 female) - 600338	0.2	3.573
AstroDon MOAG-CFW-A	0.2	3.373
AstroDon - MMOAG	1.25	2.123
AstroDon MOAG-CFW-A	0.2	1.923
SBIG Flat Adapter (3"-24 female) - 600337	0.2	1.723
STXL w/filter wheel FW8S-STXL	1.723	0

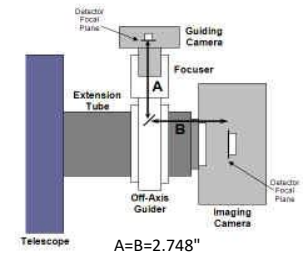

STXL w/ Self Guiding FW		10.24 remaining BF
Focuser racked in	3	7.24
Focuser position (0-1.3")	0.242	6.998
SecureFit CCD Spacer - 200361-2	2.1	4.898
CCD Adapter STX - 600335	0.922	3.976
AO-X (w/ threaded adapter attached)	1.38	2.596
AO-X to FW adapter (SBIG)	0.2	2.396
STXL w/FW8G-STXL Attached	2.396	0

PLANEWAVE INSTRUMENTS
CDK17 SECUREFIT CCD SPACERS FOR ST CAMERAS

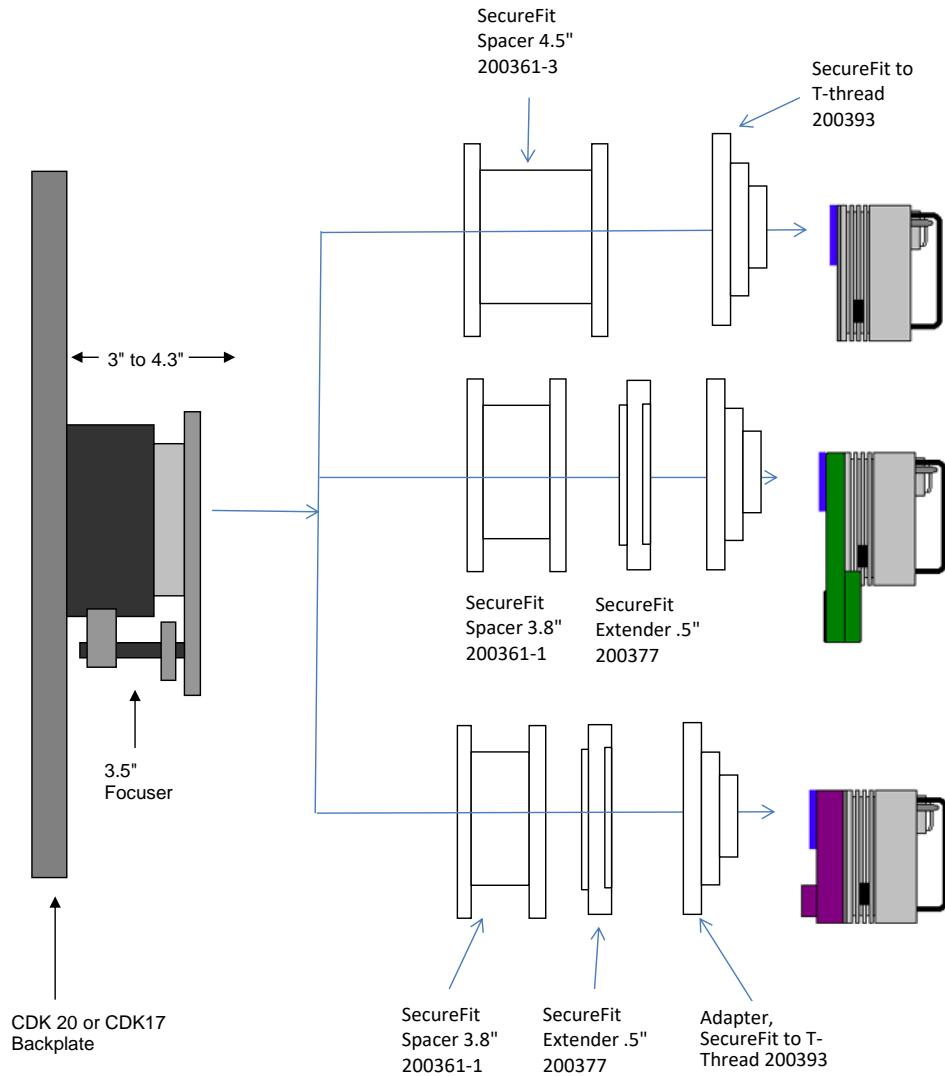

SecureFit w/ ST	10.24	remaining BF
Focuser racked in	3	7.24
Focuser Position (0 - 1.3")	0.678	6.562
SecureFit 4.5 - 200361-3	4.5	2.062
CCD SecureFit Extender - 200377	0.5	1.562
Adapter, SecureFit to T thread - 200393	0.55	1.012
ST Back Focus (with D-block)	1.012	0

SecureFit with ST and CFW10	10.24	remaining BF
Focuser racked in	3	7.24
Focuser Position (0 - 1.3")	0.798	6.442
SecureFit Spacer 3.8- 200361-1	3.8	2.642
SecureFit Extender - 200377	0.5	2.142
Adapter, SecureFit to T thread - 200393	0.55	1.592
ST w/ CFW10 Back Focus (with D-block)	1.592	0

SecureFit with ST and CFW10SA	10.24	remaining BF
Focuser racked in	3	7.24
Focuser Position (0 - 1.3")	0.58	6.66
SecureFit Spacer 3.8 - 200361-1	3.8	2.86
SecureFit Extender - 200377	0.5	2.36
Adapter, SecureFit to T thread - 200393	0.55	1.81
ST w/ CFW10 Back Focus, (w/ D-block)	1.81	0

SecureFit with ST and CFW8	10.24	remaining BF
Focuser racked in	3	7.24
Focuser Position (0 - 1.3")	0.378	6.862
SecureFit Spacer 3.8 - 200361-1	3.8	3.062
SecureFit Extender - 200377	0.5	2.562
Adapter, SecureFit to T thread - 200393	0.55	2.012
ST w/ CFW8 Back Focus, (w/ D-block)	2.012	0

PLANEWAVE INSTRUMENTS
CDK17 SECUREFIT CCD SPACERS FOR ST CAMERAS

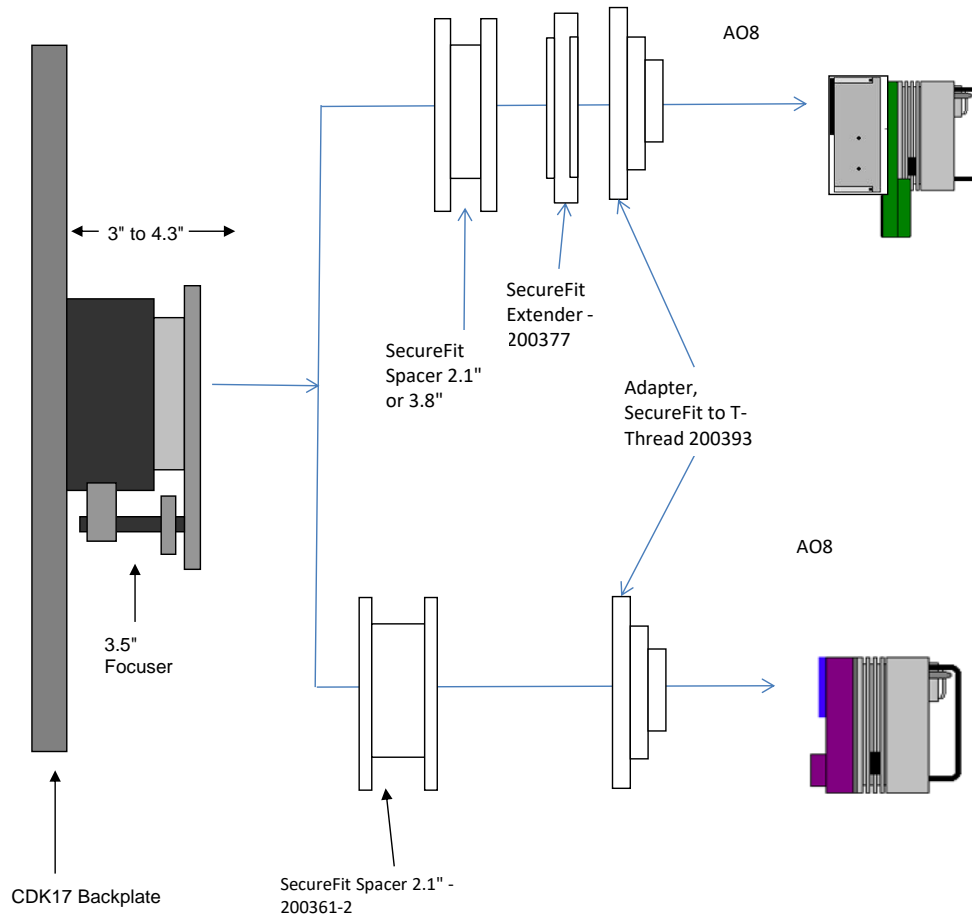

SecureFit with ST, CFW10, & AO-8		10.24 remaining BF
Focuser racked in	3	7.24
Focuser Position (0 - 1.3")	0.598	6.642
SecureFit Spacer 2.1 - 200361-2	2.1	4.542
SecureFit Extender - 200377	0.5	4.042
Adapter, SecureFit to T thread - 200393	0.55	3.492
AO-8, 1.9" of backfocus + .27 for D-block	2.17	1.322
ST w/ CFW10 Back Focus (w/o D-block)	1.322	0

SecureFit with ST and CFW10SA		10.24 remaining BF
Focuser racked in	3	7.24
Focuser Position (0 - 1.3")	0.58	6.66
SecureFit Spacer 3.8 - 200361-1	3.8	2.86
SecureFit Extender - 200377	0.5	2.36
Adapter, SecureFit to T thread - 200393	0.55	1.81
ST w/ CFW10 Back Focus, (w/ D-block)	1.81	0

SecureFit with ST, CFW8, & AO-8		10.24 remaining BF
Focuser racked in	3	7.24
Focuser Position (0 - 1.3")	0.408	6.832
SecureFit Spacer 2.1 - 200361-2	2.1	4.732
Adapter, SecureFit to T thread - 200393	0.55	4.182
AO-8, 1.9" of backfocus + .27 for D-block	2.17	2.012
ST w/ CFW8 Back Focus, (w/ D-block)	2.012	0

PLANEWAVE INSTRUMENTS
CDK17 SECUREFIT SPACERS FOR ST8300 CAMERAS

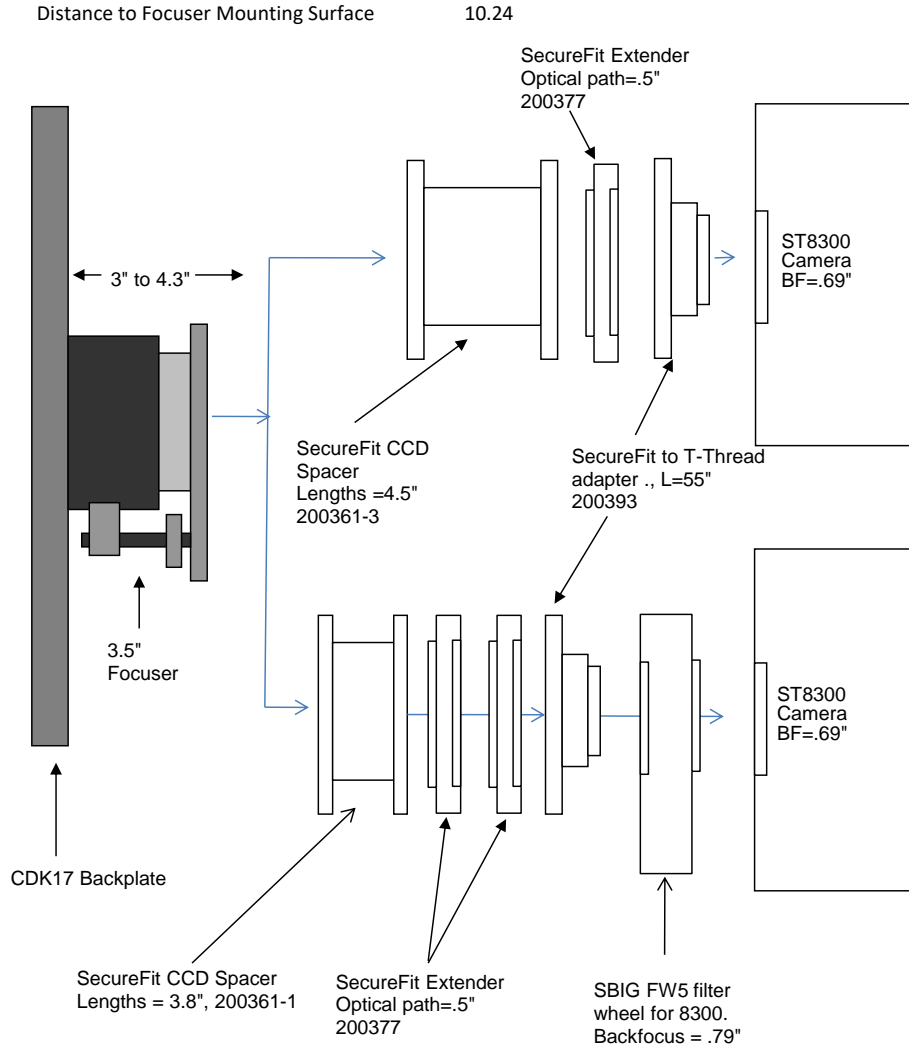

ST8300 Camera Alone		10.24 remaining BF
Focuser racked in	3	7.24
Focuser position (0-1.3")	1	6.24
CCD Spacer 4.5- 200361-3	4.5	1.74
CCD SecureFit Extender - 200377	0.5	1.24
SecureFit to T-Thread - 200393	0.55	0.69
SLT Back Focus	0.69	0

ST8300 Camera FW8 or FW5 for 8300		10.24 remaining BF
Focuser racked in	3	7.24
Focuser position (0-1.3")	0.41	6.83
CCD Spacer 3.8 - 200361-1	3.8	3.03
CCD SecureFit Extender - 200377	0.5	2.53
CCD SecureFit Extender - 200377	0.5	2.03
SecureFit to T-Thread - 200393	0.55	1.48
FW5 or 8 for 8300, Back Focus=.79"	0.79	0.69
SLT Back Focus	0.69	0

PLANEWAVE INSTRUMENTS
CDK17 SECUREFIT SPACERS FOR STT CAMERAS

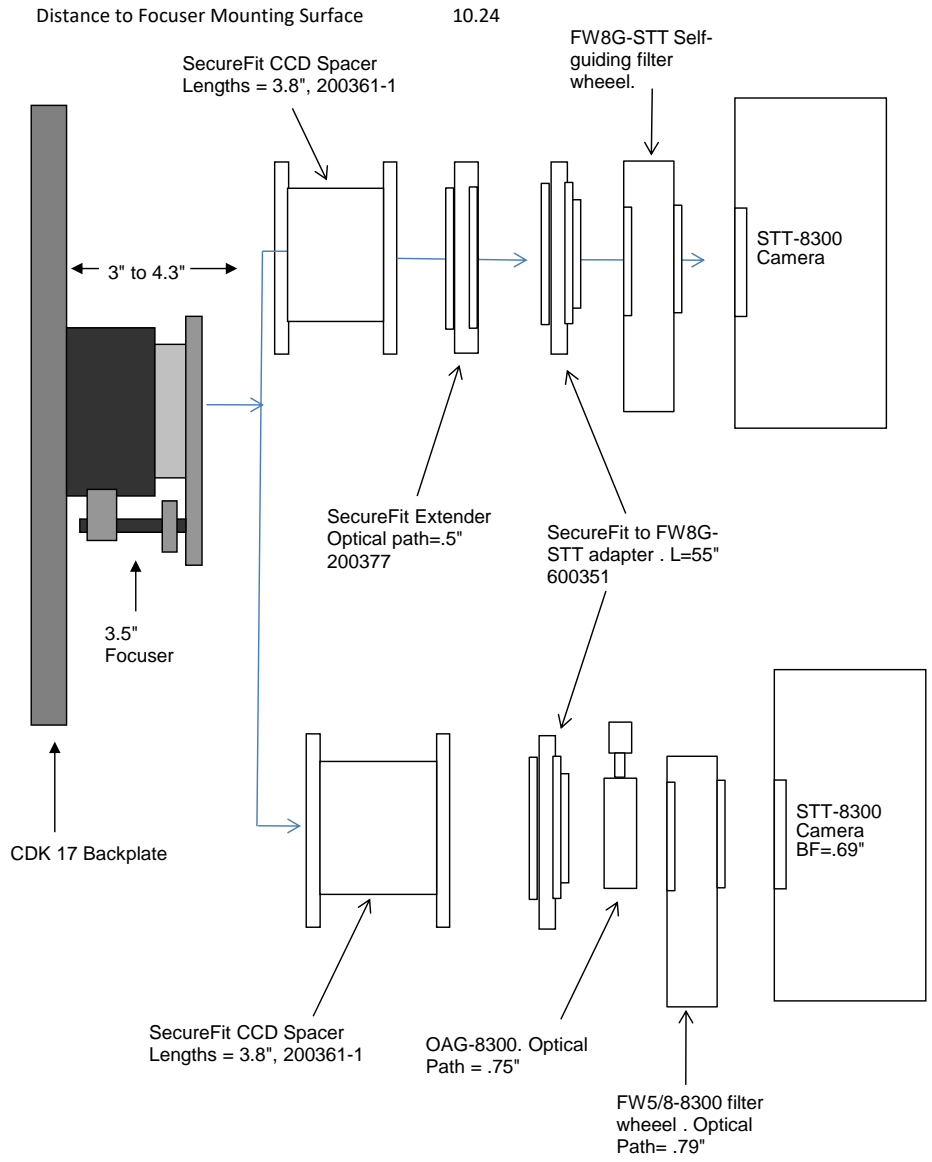

STT8300 Camera w/ Self Guiding Filter Wheel	10.24	remaining BF
Focuser racked in	3	7.24
Focuser position (0-1.3")	0.262	6.978
SecureFit Spacer 3.8- 200361-1	3.8	3.178
CCD SecureFit Extender - 200377	0.5	2.678
SecureFit to FW8G-STT - 600351	0.55	2.128
FW8G-SST attached to STT-8300 Camera	2.128	0

STT8300 Camera w/Filter Wheel, OAG8300	10.24	remaining BF
Focuser racked in	3	7.24
Focuser position (0-1.3")	0.64	6.6
SecureFit Spacer 3.8- 200361-1	3.8	2.8
SecureFit to FW8G-STT - 600351	0.55	2.25
OAG-8300	0.75	1.5
STT-8300 w/ FW5-8300 attached	1.5	0

PLANEWAVE INSTRUMENTS
CDK17 SECUREFIT SPACERS FOR STL CAMERAS

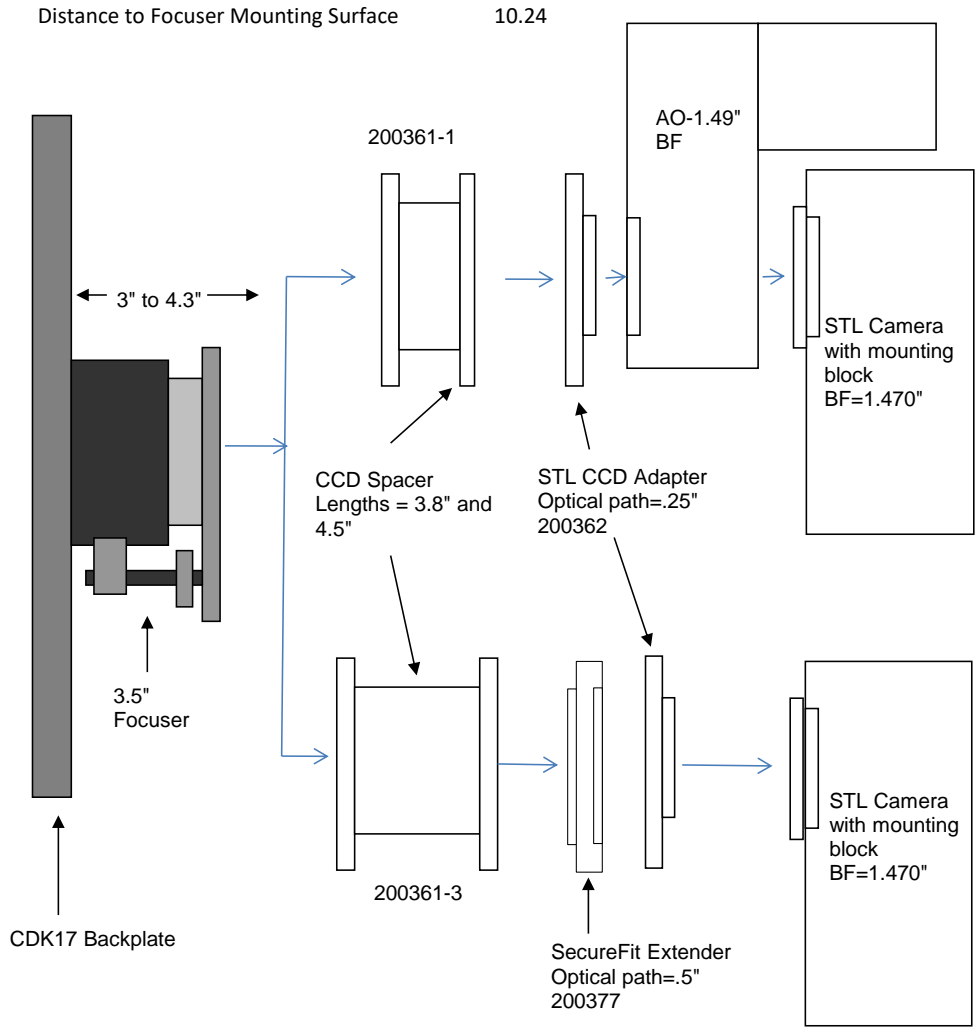

STL and AO-L	10.24 remaining BF	
Focuser racked in	3	7.24
Focuser position (0-1.3")	0.23	7.01
CCD Spacer 3.8 - 200361-1	3.8	3.21
CCD Adapter STL - 200362	0.25	2.96
AO-L	1.49	1.47
STL Back Focus	1.47	0

STL Camera Alone	10.24 remaining BF	
Focuser racked in	3	7.24
Focuser position (0-1.3")	0.52	6.72
CCD Spacer 4.5" - 200361-3	4.5	2.22
CCD SecureFit Extender - 200377	0.5	1.72
CCD Adapter STL - 200362	0.25	1.47
SLT Back Focus	1.47	0

PLANEWAVE INSTRUMENTS
CDK 17 SPACERS FOR STL CAMERAS

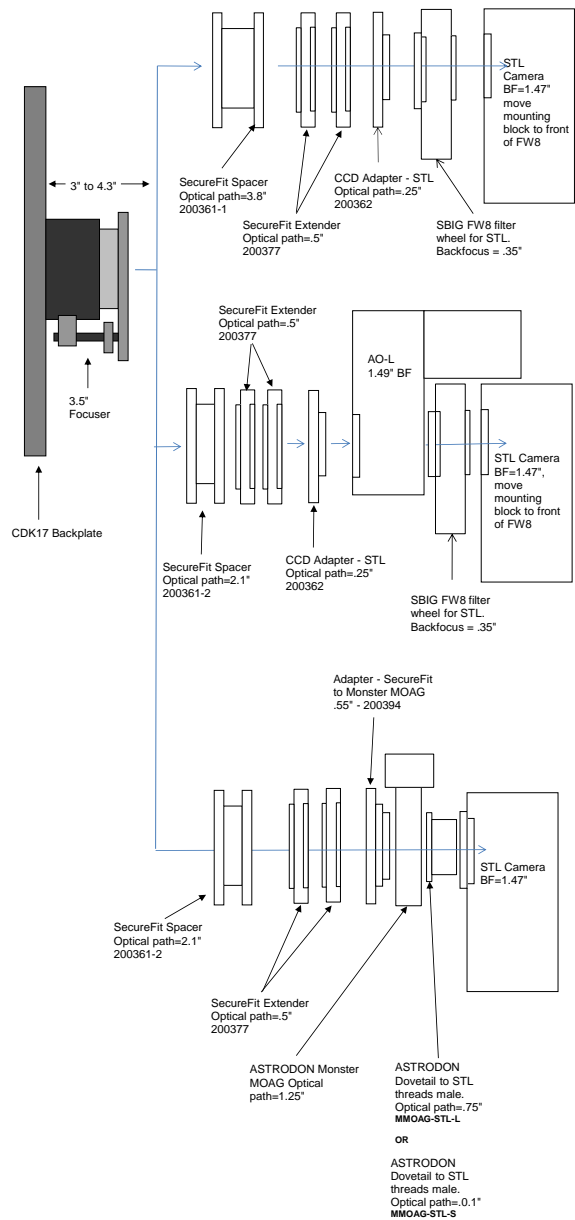

STL w/ FW8	10.24	remaining BF
Focuser racked in	3	7.24
Focuser position (0-1.3")	0.37	6.87
CCD Spacer 3.8" - 200361-1	3.8	3.07
CCD SecureFit Extender - 200377	0.5	2.57
CCD SecureFit Extender - 200377	0.5	2.07
CCD Adapter STL - 200362	0.25	1.82
FW8	0.35	1.47
SLT Back Focus	1.47	0

STL w/ FW8 and AO-L	10.24	remaining BF
Focuser racked in	3	7.24
Focuser position (0-1.3")	0.58	6.66
CCD Spacer 2.1 - 200361-2	2.1	4.56
CCD SecureFit Extender - 200377	0.5	4.06
CCD SecureFit Extender - 200377	0.5	3.56
CCD Adapter STL - 200362	0.25	3.31
AO-L	1.49	1.82
FW8	0.35	1.47
SLT Back Focus	1.47	0

STL camera and MMOAG	10.24	remaining BF
Focuser racked in	3	7.24
Focuser position (0-1.3")	0.62	6.62
CCD Spacer 2.1 - 200361-2	2.1	4.52
SecureFit 1/2" Spacer - 200377	0.5	4.02
CCD SecureFit to MMOAG - 200394	0.55	3.47
Monster MOAG	1.25	2.22
MMOAG-STL-L	0.75	1.47
SLT Back Focus	1.47	0

STL camera and MMOAG	10.24	remaining BF
Focuser racked in	3	7.24
Focuser position (0-1.3")	0.77	6.47
CCD Spacer 2.1 - 200361-2	2.1	4.37
SecureFit 1/2" Spacer - 200377	0.5	3.87
SecureFit 1/2" Spacer - 200377	0.5	3.37
CCD SecureFit to MMOAG - 200394	0.55	2.82
AstroDon part - MMOAG	1.25	1.57
AstroDon part - MMOAG-STL-S	0.1	1.47
SLT Back Focus	1.47	0

PLANEWAVE INSTRUMENTS
CDK 17 SPACERS FOR STL CAMERAS

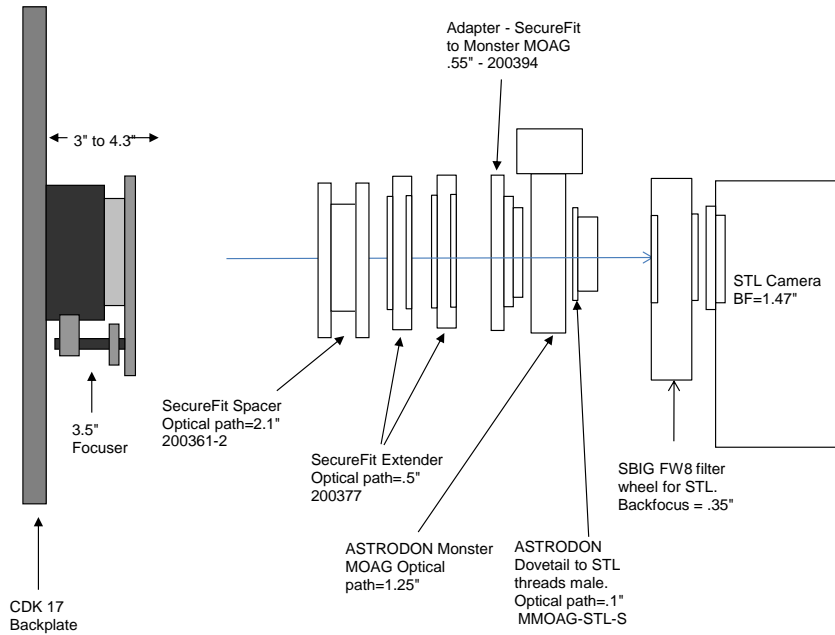

STL camera and MMOAG		10.24 remaining BF
Focuser racked in	3	7.24
Focuser position (0-1.3")	0.42	6.82
CCD Spacer 2.1 - 200361-2	2.1	4.72
SecureFit 1/2" Spacer - 200377	0.5	4.22
SecureFit 1/2" Spacer - 200377	0.5	3.72
CCD SecureFit to MMOAG - 200394	0.55	3.17
AstroDon part - MMOAG	1.25	1.92
AstroDon part - MMOAG-STL-S	0.1	1.82
Filter Wheel, FW8	0.35	1.47
SLT Back Focus	1.47	0

STL camera and MMOAG, IRF90		10.24 remaining BF
IRF 90 Focuser (600180)	3.5	6.74
Focuser position (0-1.3")	0.42	6.32
CCD Spacer 2.1 - 200361-2	2.1	4.22
SecureFit 1/2" Spacer - 200377	0.5	3.72
CCD SecureFit to MMOAG - 200394	0.55	3.17
AstroDon part - MMOAG	1.25	1.92
AstroDon part - MMOAG-STL-S	0.1	1.82
Filter Wheel, FW8	0.35	1.47
SLT Back Focus	1.47	0

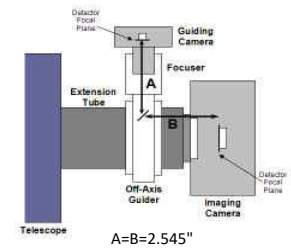
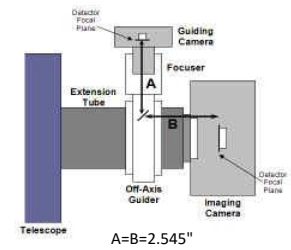

PLANEWAVE INSTRUMENTS
CDK 20 and 24 SPACERS FOR STX CAMERAS

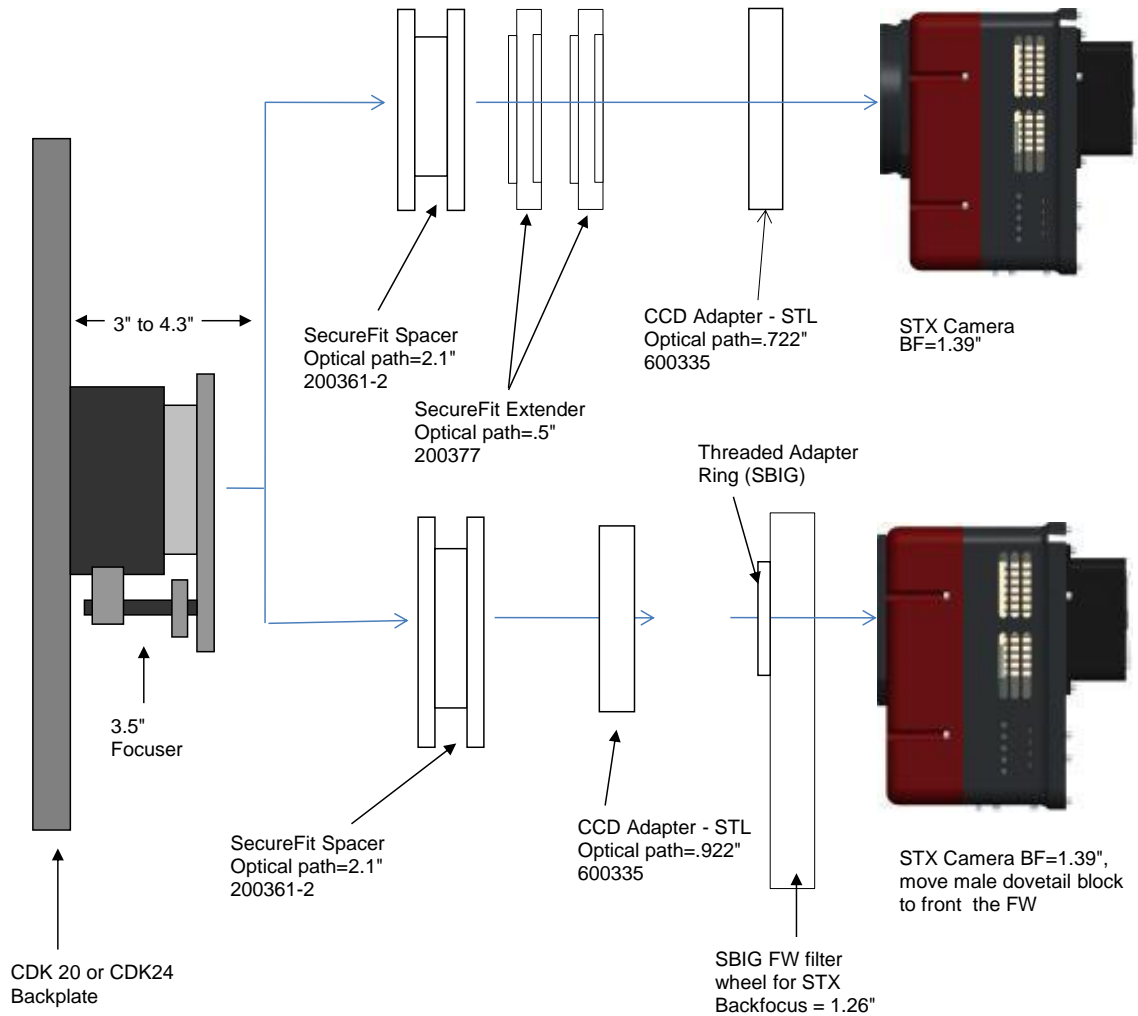

STX	8.81 remaining BF	
Focuser racked in	3	5.81
Focuser position (0-1.3")	0.598	5.212
CCD Spacer 2.1 - 200361-2	2.1	3.112
CCD SecureFit Extender - 200377	0.5	2.612
CCD SecureFit Extender - 200377	0.5	2.112
CCD Adapter STX - 600335	0.722	1.39
STX Back Focus w/threaded adapter ring attached	1.39	0

STX w/ FW	8.81 remaining BF	
Focuser racked in	3	5.81
Focuser position (0-1.3")	0.138	5.672
CCD Spacer 2.1 - 200361-2	2.1	3.572
CCD Adapter STX - 600335	0.922	2.65
Filter Wheel w/threaded adapter ring attached	1.26	1.39
STX Camera	1.39	0

PLANEWAVE INSTRUMENTS
CDK20 SPACERS FOR STX CAMERAS

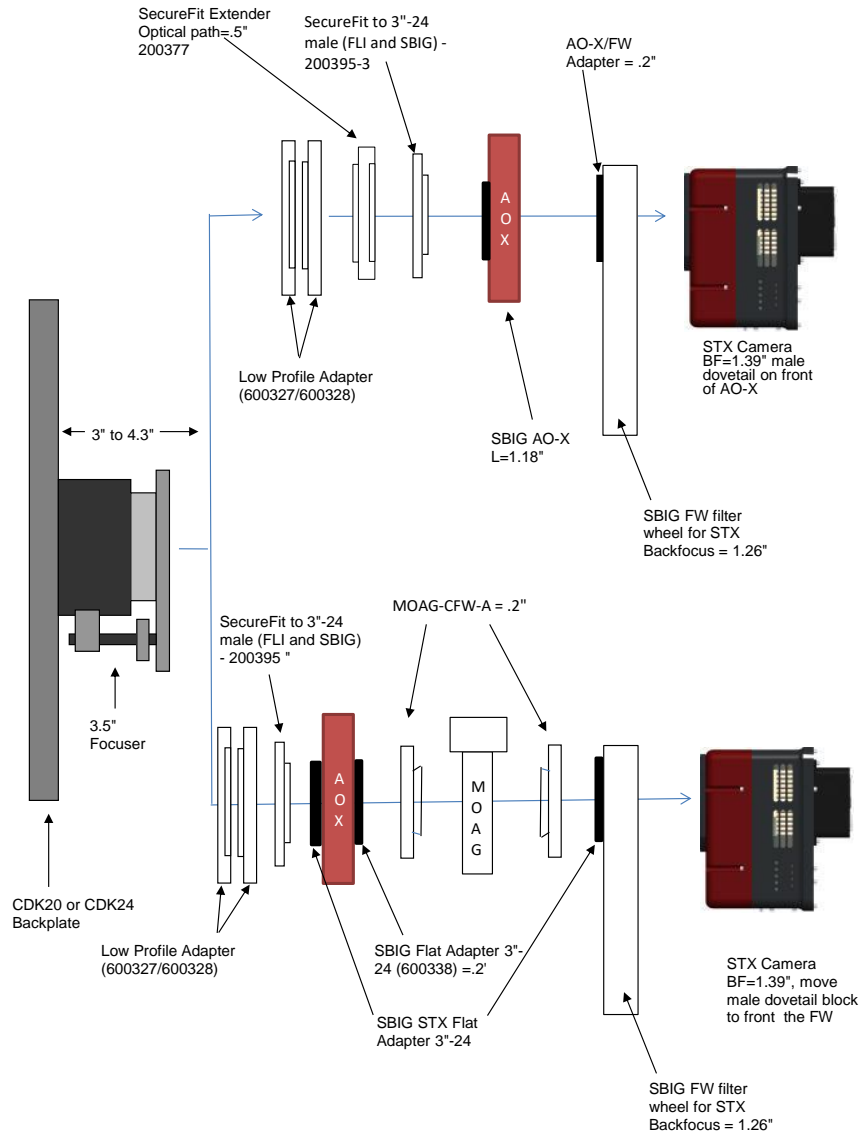

STX camera, AO-X, CFW	8.81	remaining BF
IRF90 Focuser racked in	3	5.81
Focuser position (0-1.3")	0.33	5.48
Low Profile Adapters = .5" (600327/328)	0.5	4.98
SecureFit Extender .5" (200377)	0.5	4.48
SecureFit to 3"-24 male (FLI and SBIG) - 200395-3	0.25	4.23
STX Flat adapter 3"-24 Female -600337	0.2	4.03
AO-X	1.18	2.85
AO-X to FW adapter (SBIG)	0.2	2.65
SBIG Filter Wheel (w/.2" adapter)	1.26	1.39
STX Back Focus	1.39	0

STX camera, AO-X, CFW, IRF90	8.81	remaining BF
IRF90 Focuser racked in	3.5	5.31
Focuser position (0-1.3")	0.33	4.98
Low Profile Adapters = .5" (600327/328)	0.5	4.48
SecureFit to 3"-24 male (FLI and SBIG) - 200395-3	0.25	4.23
STX Flat adapter 3"-24 Female -600337	0.2	4.03
AO-X	1.18	2.85
AO-X to FW adapter (SBIG)	0.2	2.65
SBIG Filter Wheel (w/.2" adapter)	1.26	1.39
STX Back Focus	1.39	0

*This configuration will not reach focus with the CDK20 but can work on the CDK24 with custom adapter

STX camera and MMOAG	8.81	remaining BF
Focuser racked in	3	5.81
Focuser position (0-1.3")	0	5.81
Low profile adapters- 600327/328	0.5	5.31
SecureFit to 3"-24 male (FLI and SBIG) - 200395-3	0.25	5.06
STX Flat adapter 3"-24 Female -600337	0.2	4.86
AO-X	1.18	3.68
STX Flat adapter 3"-24 Female -600338	0.2	3.48
MOAG-CFW-A	0.2	3.28
AstroDon part - MMOAG	1.25	2.03
MOAG-CFW-A	0.2	1.83
STX Flat adapter 3"-24 Female -600337	0.2	1.63
Filter Wheel, FW8	1.26	0.37
SLX Back Focus	1.39	-1.02

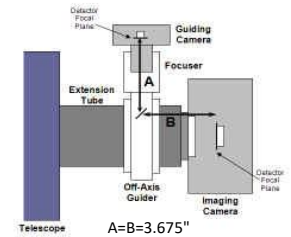

PLANEWAVE INSTRUMENTS
CDK 20 & 24 SPACERS FOR STXL CAMERAS

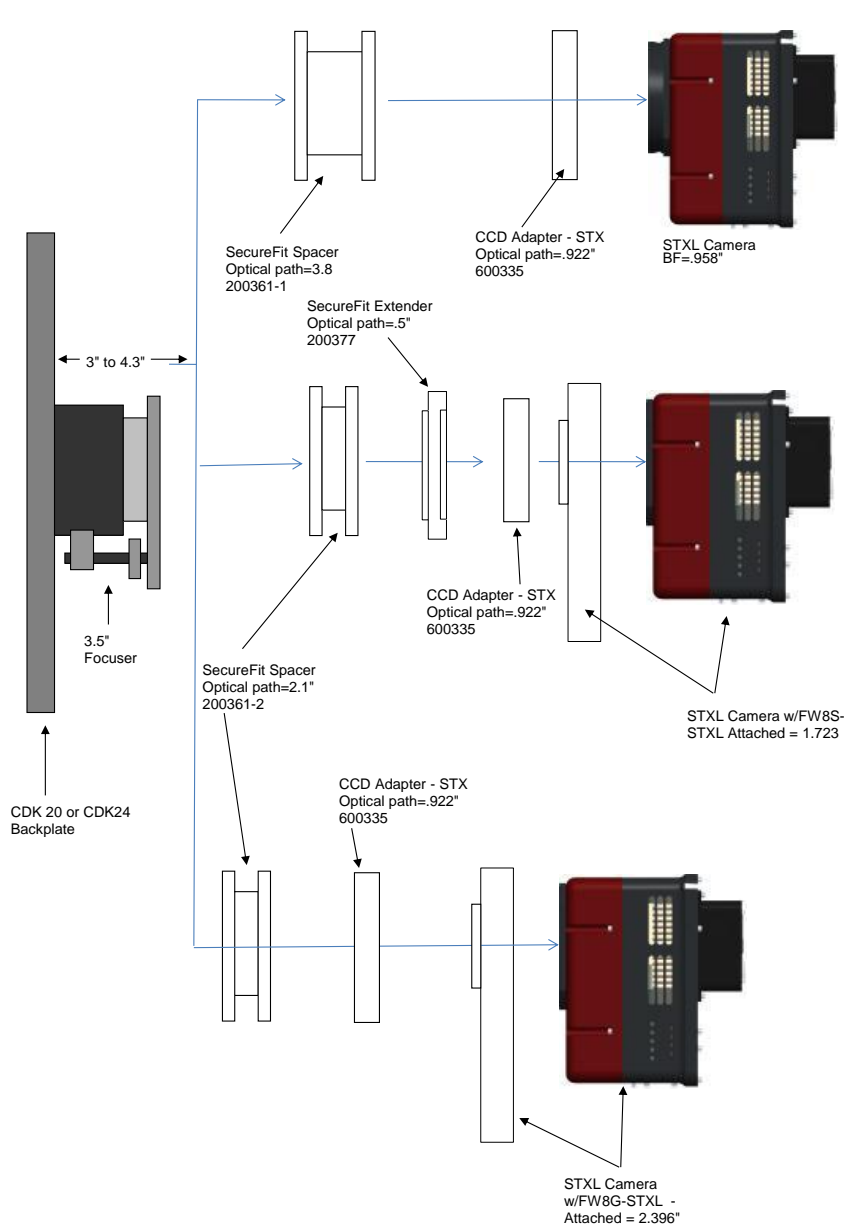

STXL		8.81 remaining BF
Focuser (200340) racked in	3	5.81
Focuser position (0-1.3")	0.33	5.48
CCD Spacer 2.1 - 200361-1	3.8	1.68
CCD Adapter STX - 600335	0.722	0.958
STXL Camera	0.958	0

STXL w/IRF90		8.81 remaining BF
Focuser (600180) racked in	3.5	5.31
Focuser position (0-1.3")	0.33	4.98
CCD Spacer 2.1 - 200361-2	2.1	2.88
CCD SecureFit Extender - 200377	0.5	2.38
CCD SecureFit Extender - 200377	0.5	1.88
CCD Adapter STX - 600335	0.922	0.958
STXL Camera	0.958	0

STXL w/ Standard FW		8.81 remaining BF
Focuser (200340) racked in	3	5.81
Focuser position (0-1.3")	0.565	5.245
CCD Spacer 2.1 - 200361-2	2.1	3.145
CCD SecureFit Extender - 200377	0.5	2.645
CCD Adapter STX - 600335	0.922	1.723
STXL Camera w/FW8S-STXL Attached	1.723	0

STXL w/ Standard FW & IRF90		8.81 remaining BF
Focuser (600180) racked in	3.5	5.31
Focuser position (0-1.3")	0.565	4.745
CCD Spacer 2.1 - 200361-2	2.1	2.645
CCD Adapter STX - 600335	0.922	1.723
STXL Camera w/FW8S-STXL Attached	1.723	0

STXL w/ Self Guiding FW		8.81 remaining BF
Focuser (200340) racked in	3	5.81
Focuser position (0-1.3")	0.392	5.418
SecureFit CCD Spacer - 200361-2	2.1	3.318
CCD Adapter STX - 600335	0.922	2.396
STXL Camera w/FW8G-STXL Attached	2.396	0

STXL w/ Self Guiding FW & IRF90		8.81 remaining BF
Focuser (600180) racked in	3.5	5.31
Focuser position (0-1.3")	0.492	4.818
Low Profile SecureFit adapters (600327/600328)	0.5	4.318
CCD SecureFit Extender - 200377	0.5	3.818
CCD SecureFit Extender - 200377	0.5	3.318
CCD Adapter STX - 600335	0.922	2.396
STXL Camera w/FW8G-STXL Attached	2.396	0

PLANEWAVE INSTRUMENTS
CDK20/24 SPACERS FOR STXL CAMERAS & AO-X

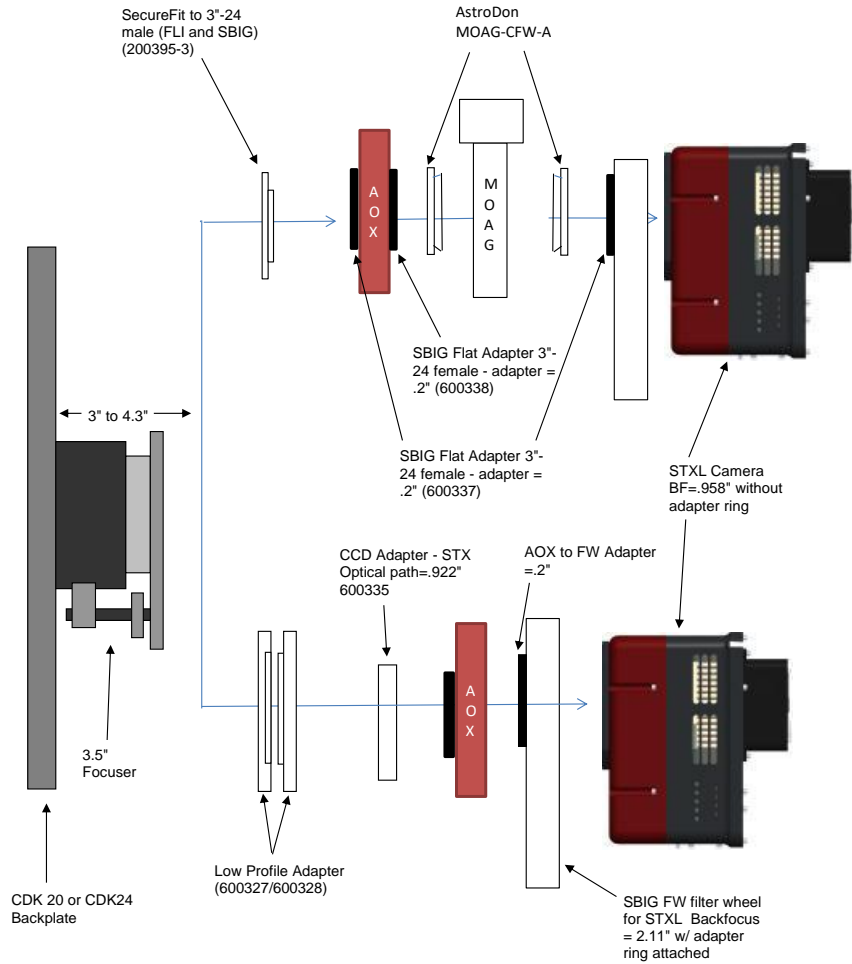

STXL camera and MMOAG &FW8S-STXL		8.81 remaining BF
Focuser racked in	3	5.81
Focuser position (0-1.3")	0.407	5.403
SecureFit to 3"-24 male (FLI and SBIG) - 200395-3	0.25	5.153
SBIG Flat Adapter - 3"-24 female - 600337	0.2	4.953
AO-X	1.18	3.773
SBIG Flat Adapter -600338	0.2	3.573
AstroDon MOAG-CFW-A	0.2	3.373
AstroDon- MMOAG	1.25	2.123
AstroDon MOAG-CFW-A	0.2	1.923
SBIG Flat Adapter - 600337	0.2	1.723
STXL w/filter wheel FW8S-STXL	1.723	0

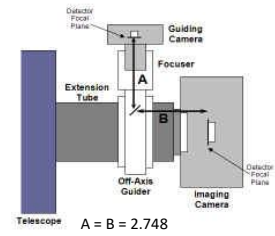

STXL w/ Self Guiding FW		8.81 remaining BF
Focuser racked in	3	5.81
Focuser position (0-1.3")	0.41	5.4
Low Profile Adapters = .5" (600327/328)	0.5	4.9
CCD Adapter STX - 600335	0.922	3.978
AOX w/SBIG Threaded Adapter attached	1.38	2.598
AOX to FW Adapter (SBIG)	0.2	2.398
Filter Wheel w/threaded adapter ring attached	1.44	0.958
STXL Back Focus	0.958	0

PLANEWAVE INSTRUMENTS
CDK20 SPACERS FOR STX CAMERAS with STX Guider

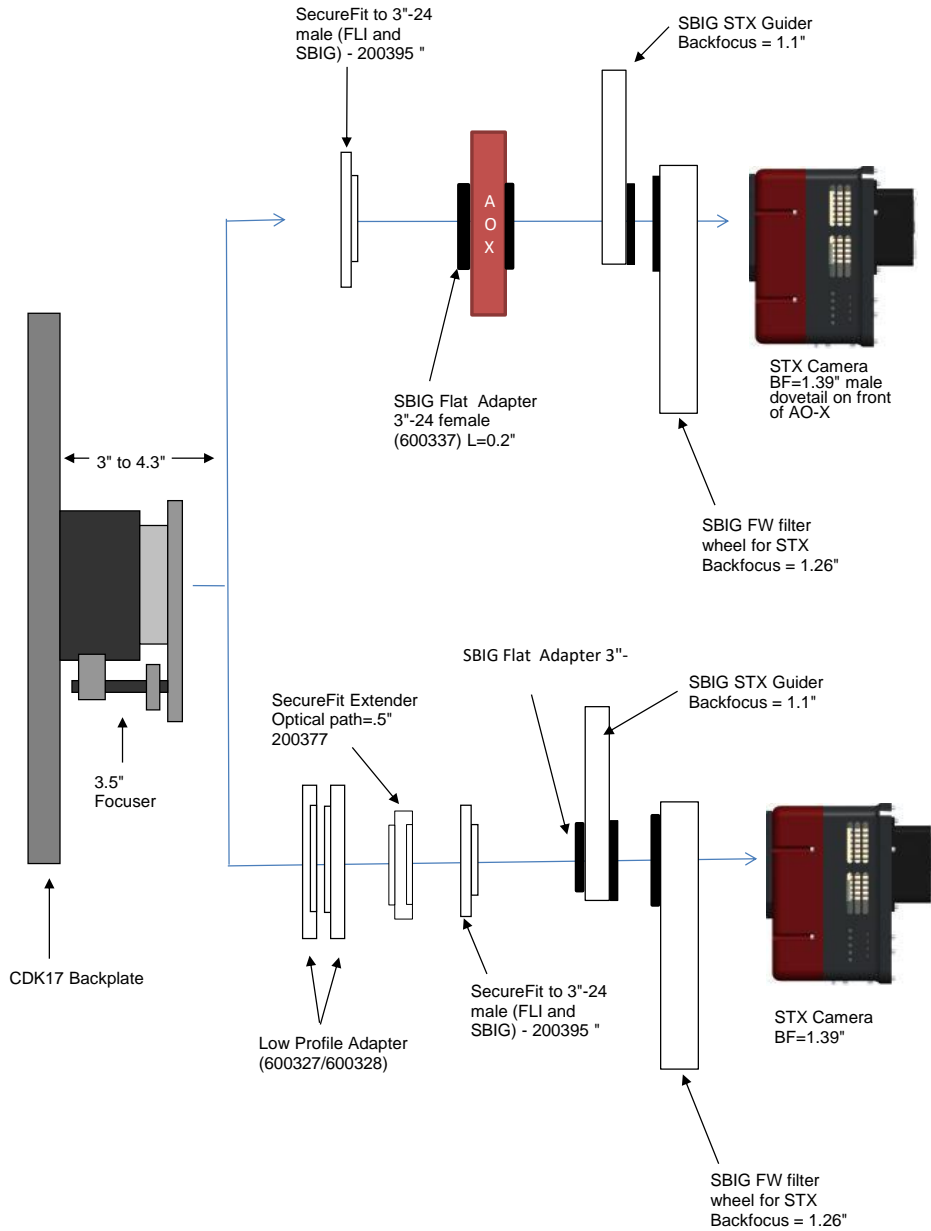

STX camera, AO-X, CFW, STX Guider		8.81 remaining BF
Focuser racked in	3	5.81
Focuser position (0-1.3")	0.23	5.58
CCD SecureFit 3-24 - 200395-3	0.25	5.33
SBIG Flat adaptet 3"-24 - 600337	0.2	5.13
AO-X	1.18	3.95
AO-X to FW adapter (SBIG)	0.2	3.75
STX Guider	1.1	2.65
SBIG Filter Wheel	1.26	1.39
STX Back Focus	1.39	0

STX camera, CFW, STX Guider		8.81 remaining BF
Focuser racked in	3	5.81
Focuser position (0-1.3")	0.56	5.25
Low Profile Adapters = .5" (600327/328)	0.5	4.75
CCD SecureFit Extender - 200377	0.5	4.25
SecureFit to 3"-24 male (FLI and SBIG) - 200395-3	0.25	4
SBIG Flat Adapter (3"-24 female) - 600337	0.25	3.75
STX Guider	1.1	2.65
SBIG Filter Wheel	1.26	1.39
STX Back Focus	1.39	0

STX camera, CFW, STX Guider w/ IRF90		8.81 remaining BF
IRF 90 racked in	3.5	5.31
Focuser position (0-1.3")	0.56	4.75
Low Profile Adapters = .5" (600327/328)	0.5	4.25
SecureFit to 3"-24 male (FLI and SBIG) - 200395-3	0.25	4
SBIG Flat Adapter (3"-24 female) - 600337	0.25	3.75
STX Guider	1.1	2.65
SBIG Filter Wheel	1.26	1.39
STX Back Focus	1.39	0

PLANEWAVE INSTRUMENTS
CDK20&24 SECUREFIT CCD SPACERS FOR ST CAMERAS

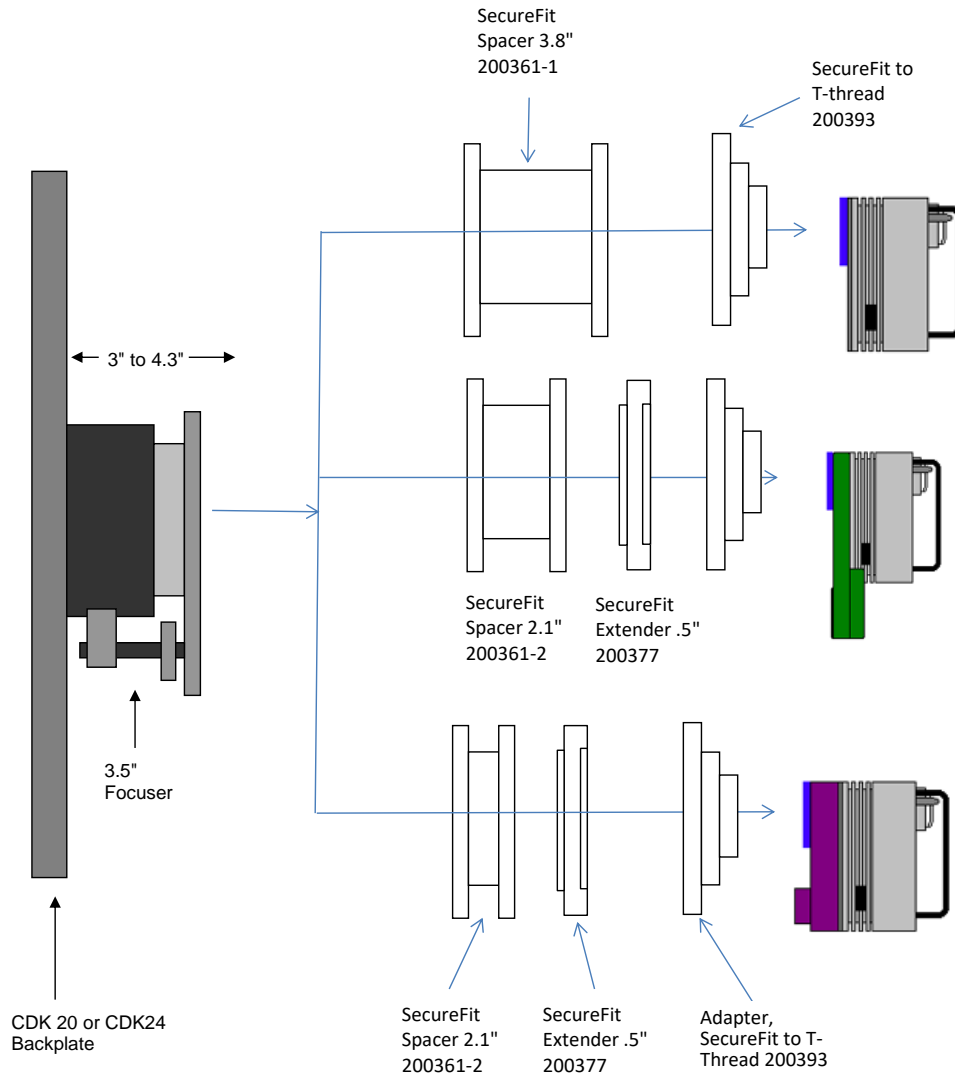

SecureFit w/ ST	8.81 remaining BF	
Focuser racked in	3	5.81
Focuser Position (0 - 1.3")	0.45	5.36
SecureFit 3.8 - 200361-1	3.8	1.56
Adapter, SecureFit to T thread - 200393	0.55	1.01
ST Back Focus (with D-block)	1.012	0.00

SecureFit with ST and CFW10	8.81 remaining BF	
Focuser racked in	3	5.81
Focuser Position (0 - 1.3")	1.068	4.742
SecureFit Spacer - 200361-2	2.1	2.642
SecureFit Extender - 200377	0.5	2.142
Adapter, SecureFit to T thread - 200393	0.55	1.592
ST w/ CFW10 Back Focus (with D-block)	1.592	0

SecureFit with ST and CFW10SA	8.81 remaining BF	
Focuser racked in	3	5.81
Focuser Position (0 - 1.3")	0.85	4.96
SecureFit Spacer - 200361-2	2.1	2.86
SecureFit Extender - 200377	0.5	2.36
Adapter, SecureFit to T thread - 200393	0.55	1.81
ST w/ CFW10 Back Focus, (w/ D-block)	1.81	0

SecureFit with ST and CFW8	8.81 remaining BF	
Focuser racked in	3	5.81
Focuser Position (0 - 1.3")	0.648	5.162
SecureFit Spacer - 200361-2	2.1	3.062
SecureFit Extender - 200377	0.5	2.562
Adapter, SecureFit to T thread - 200393	0.55	2.012
ST w/ CFW8 Back Focus, (w/ D-block)	2.012	0

PLANEWAVE INSTRUMENTS
CDK20 & 24 SECUREFIT CCD SPACERS FOR ST CAMERAS

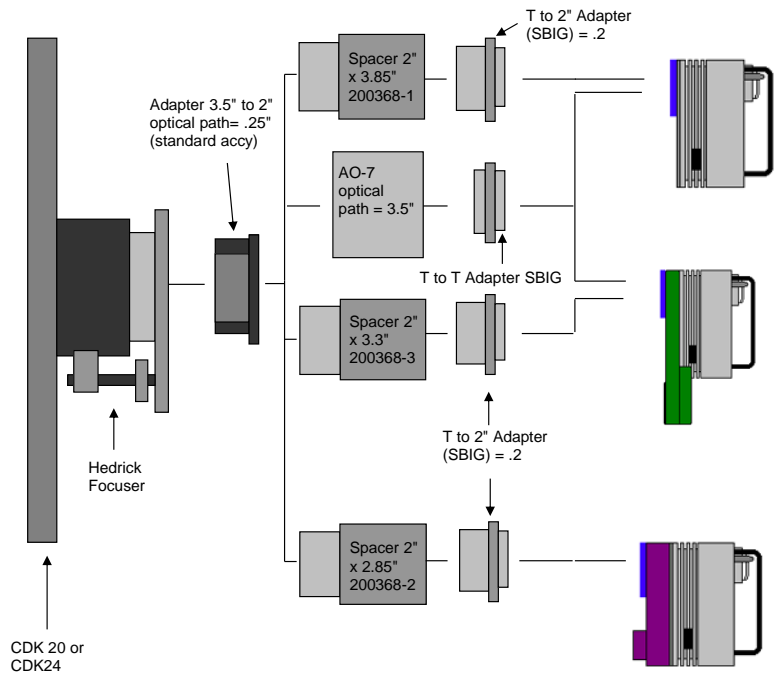

ST Camera, no filter wheel			8.81 remaining BF
Focuser racked in	3		5.81
Focuser Position (0 - 1.3")	0.498		5.312
Adapter, 3 to 2 (standard accy)	0.25		5.062
CCD 2" Spacer x 3.85" - 200368-1	3.85		1.212
T to 2 Adapter (SBIG)	0.2		1.012
ST Back Focus (with D-Block)	1.012		0

ST Camera with CFW10 w/ D-Block			8.81 remaining BF
Focuser racked in	3		5.81
Focuser Position (0 - 1.3")	0.468		5.342
Adapter, 3 to 2 (standard accy)	0.25		5.092
CCD 2" SPACER x 3.3" - 200368-3	3.3		1.792
T to 2 Adapter (SBIG)	0.2		1.592
ST Back Focus (with D-Block)	1.592		0

ST Camera with CFW8 w/ D-Block			8.81 remaining BF
Focuser racked in	3		5.81
Focuser Position (0 - 1.3")	0.498		5.312
Adapter, 3 to 2 (standard accy)	0.25		5.062
CCD 2" SPACER x 2.85" - 200368-2	2.85		2.212
T to 2 Adapter (SBIG)	0.2		2.012
ST Back Focus (with D-Block)	2.012		0

ST Camera + AO-7			8.81 remaining BF
Focuser racked in	3		5.81
Focuser Position (0 - 1.3")	0.85		4.96
Adapter, 3 to 2	0.25		4.71
T to T Adapter (SBIG)	0.2		4.51
ST + AO-7 backfocus	4.51		0

ST + CFW10 + AO-7			8.81 remaining BF
Focuser racked in	3		5.81
Focuser Position (0 - 1.3")	0.27		5.54
Adapter, 3 to 2	0.25		5.29
T to T Adapter (SBIG)	0.2		5.09
ST + AO-7 backfocus	5.09		0

DOES NOT HAVE ENOUGH BACK FOCUS

ST + CFW8 + AO-7			8.81 remaining BF
Focuser racked in	3		5.81
Focuser Position (0 - 1.3")	0		5.81
Adapter, 3 to 2	0.25		5.56
T to 2 Adapter (SBIG)	0.2		5.36
ST + AO-7 backfocus	5.51		-0.15

PLANEWAVE INSTRUMENTS
CDK20&24 SECUREFIT CCD SPACERS FOR ST CAMERAS

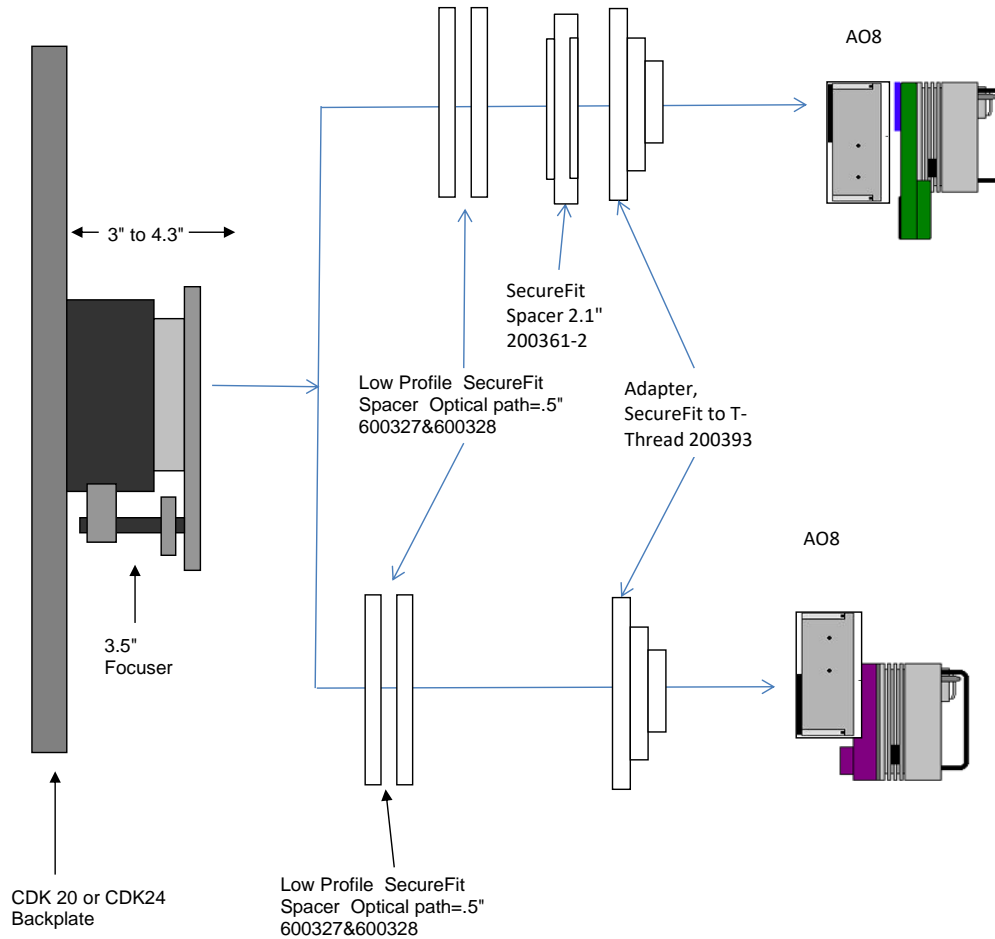

SecureFit with ST, CFW10, & AO-8		8.81 remaining BF
Focuser racked in	3	5.81
Focuser Position (0 - 1.3")	0.768	5.042
SecureFit Low Profile - 600327, 600328	0.5	4.542
SecureFit Extender - 200377	0.5	4.042
Adapter, SecureFit to T thread - 200393	0.55	3.492
AO-8, 1.9" of backfocus + .27 for D-block	2.17	1.322
ST w/ CFW10 Back Focus (w/o D-block)	1.322	0

SecureFit with ST and CFW10SA		8.81 remaining BF
Focuser racked in	3	5.81
Focuser Position (0 - 1.3")	0.85	4.96
SecureFit Spacer - 200361-2	2.1	2.86
SecureFit Extender - 200377	0.5	2.36
Adapter, SecureFit to T thread - 200393	0.55	1.81
ST w/ CFW10 Back Focus, (w/ D-block)	1.81	0

SecureFit with ST, CFW8, & AO-8		8.81 remaining BF
Focuser racked in	3	5.81
Focuser Position (0 - 1.3")	0.578	5.232
SecureFit Low Profile - 600327, 600328	0.5	4.732
Adapter, SecureFit to T thread - 200393	0.55	4.182
AO-8, 1.9" of backfocus + .27 for D-block	2.17	2.012
ST w/ CFW8 Back Focus, (w/ D-block)	2.012	0

PLANEWAVE INSTRUMENTS
CDK20 & 24 SECUREFIT SPACERS FOR STL CAMERAS

Distance to Focuser Mounting Surface

8.81

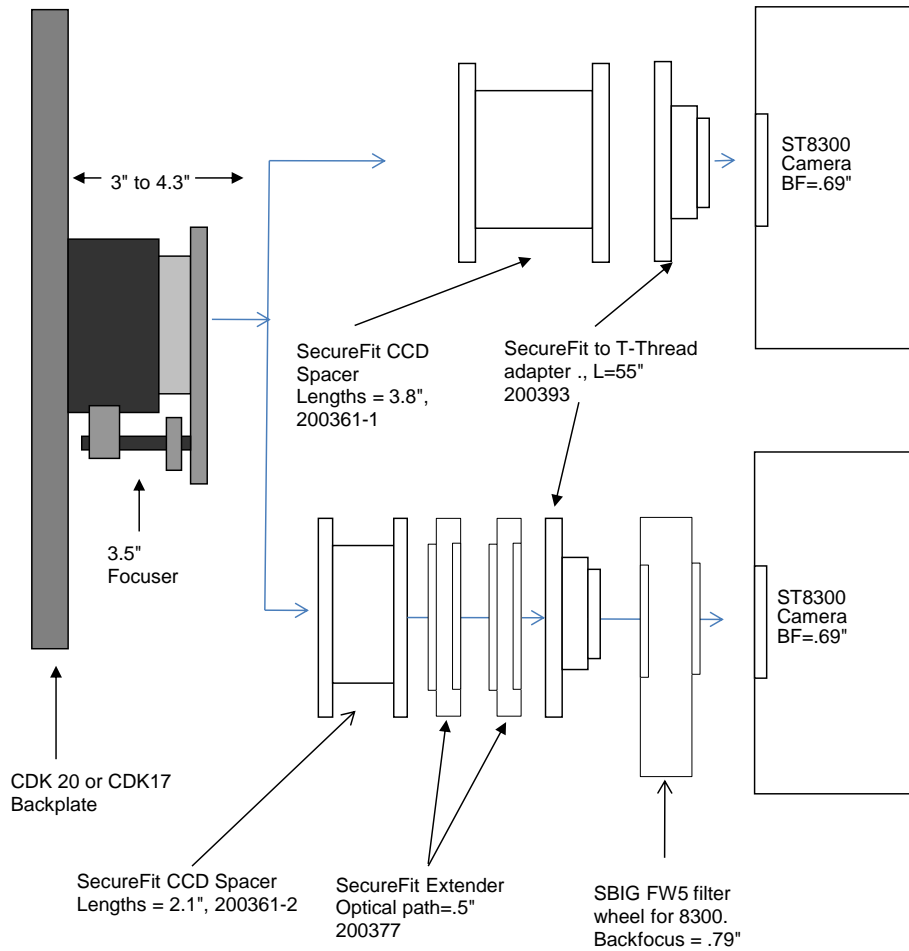

ST8300 Camera Alone		8.81 remaining BF
Focuser racked in	3	5.81
Focuser position (0-1.3")	0.77	5.04
CCD Spacer 3.8 - 200361-1	3.8	1.24
SecureFit to T-Thread - 200393	0.55	0.69
SLT Back Focus	0.69	0.00

ST8300 Camera FW8 or FW5 for 8300		8.81 remaining BF
Focuser racked in	3	5.81
Focuser position (0-1.3")	0.68	5.13
CCD Spacer 3.8 - 200361-2	2.1	3.03
CCD SecureFit Extender - 200377	0.5	2.53
CCD SecureFit Extender - 200377	0.5	2.03
SecureFit to T-Thread - 200393	0.55	1.48
FW5 or 8 for 8300, Back Focus=.79"	0.79	0.69
SLT Back Focus	0.69	0

PLANEWAVE INSTRUMENTS
CDK20/24 SECUREFIT SPACERS FOR STT CAMERAS

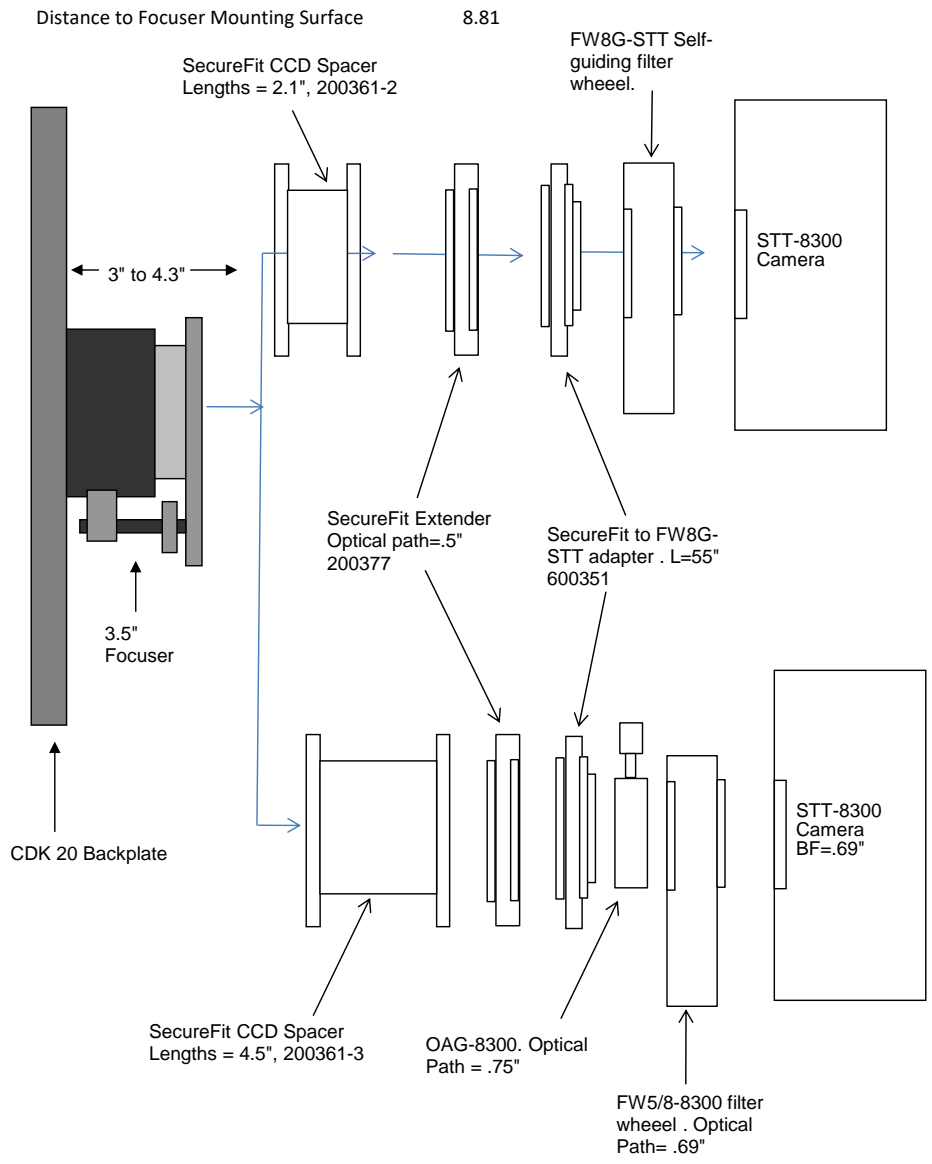

STT8300 Camera w/ Self Guiding Filter Wheel		8.81 remaining BF
Focuser racked in	3	5.81
Focuser position (0-1.3")	0.532	5.278
SecureFit Spacer 2.1- 200361-2	2.1	3.178
CCD SecureFit Extender - 200377	0.5	2.678
SecureFit to FW8G-STT - 600351	0.55	2.128
FW8G-SST attached to STT-8300 Camera	2.128	0

STT8300 Camera w/Filter Wheel, OAG8300		8.81 remaining BF
Focuser racked in	3	5.81
Focuser position (0-1.3")	0.43	5.38
SecureFit Spacer 3.8- 200361-1	2.1	3.28
CCD SecureFit Extender - 200377	0.5	2.78
SecureFit to FW8G-STT - 600351	0.55	2.23
OAG-8300	0.75	1.48
FW5-8300 / FW8-8300	0.79	0.69
STT-8300 Camera	0.69	0

PLANEWAVE INSTRUMENTS
CDK20, 24 SECUREFIT SPACERS FOR STL CAMERAS

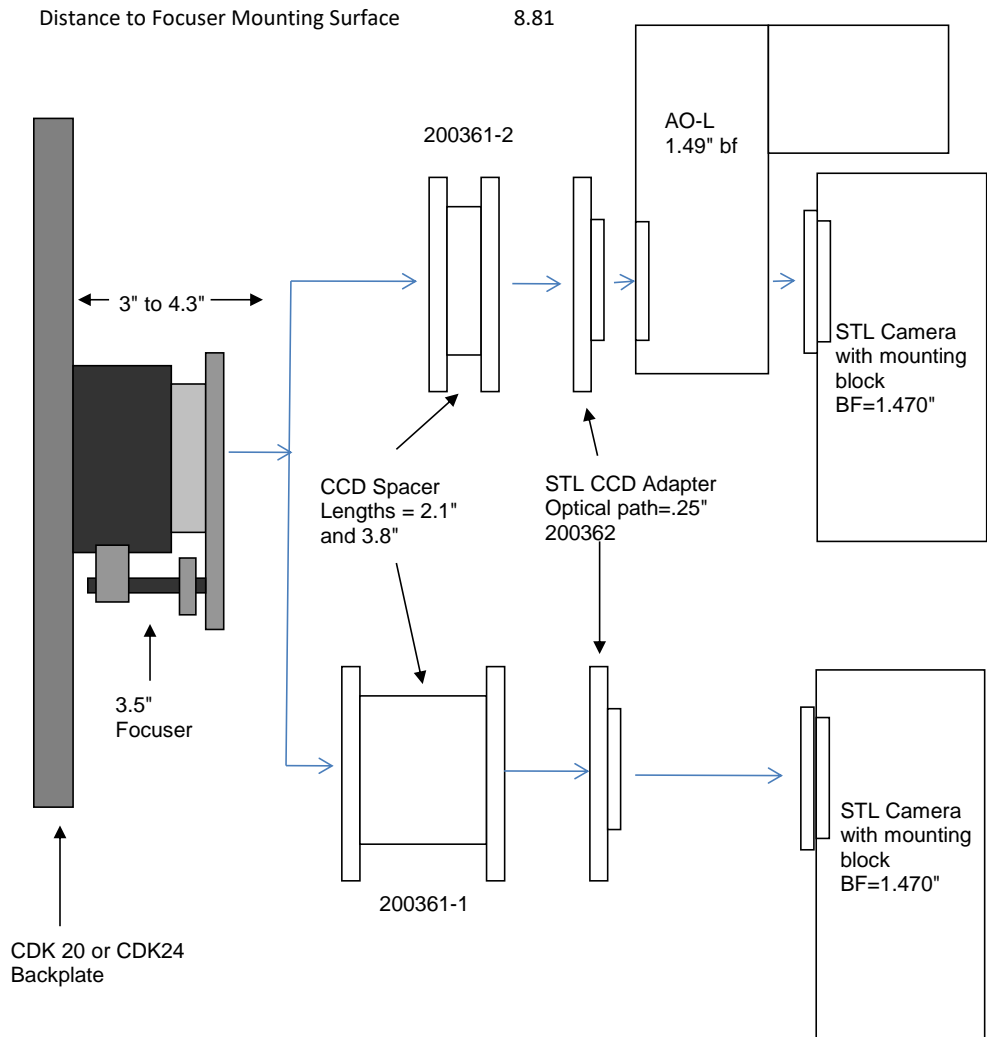

STL and AO-L	8.81 remaining BF	
Focuser racked in	3	5.81
Focuser position (0-1.3")	0.5	5.31
CCD Spacer 2.1 - 200361-2	2.1	3.21
CCD Adapter STL - 200362	0.25	2.96
AO-L	1.49	1.47
STL Back Focus	1.47	0

STL Camera Alone	8.81 remaining BF	
Focuser racked in	3	5.81
Focuser position (0-1.3")	0.29	5.52
CCD Spacer 3.8 - 200361-1	3.8	1.72
CCD Adapter STL - 200362	0.25	1.47
SLT Back Focus	1.47	0

PLANEWAVE INSTRUMENTS
CDK 20, AND 24 SPACERS FOR STL CAMERAS

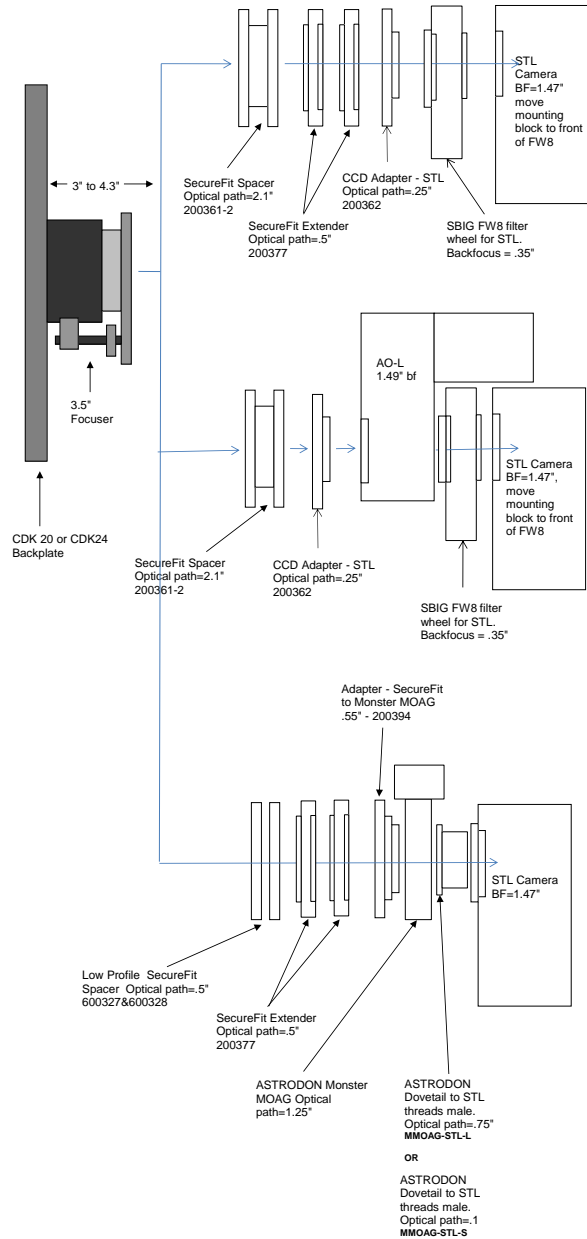

STL w/ FW8		
8.81 remaining BF		
Focuser racked in	3	5.81
Focuser position (0-1.3")	0.64	5.17
CCD Spacer 2.1 - 200361-2	2.1	3.07
CCD SecureFit Extender - 200377	0.5	2.57
CCD SecureFit Extender - 200377	0.5	2.07
CCD Adapter STL - 200362	0.25	1.82
FW8	0.35	1.47
SLT Back Focus	1.47	0

STL w/ FW8 and AO-L		
8.81 remaining BF		
Focuser racked in	3	5.81
Focuser position (0-1.3")	0.15	5.66
CCD Spacer 2.1 - 200361-2	2.1	3.56
CCD Adapter STL - 200362	0.25	3.31
AO-L	1.49	1.82
FW8	0.35	1.47
SLT Back Focus	1.47	0

STL camera and MMOAG		
8.81 remaining BF		
Focuser racked in	3	5.81
Focuser position (0-1.3")	0	5.81
LowProfile SecureFit Spacer - 0.5", 600327&328	0.5	5.31
SecureFit 1/2" Spacer - 200377	0.5	4.81
CCD SecureFit to MMOAG - 200394	0.55	4.26
Monster MOAG	1.25	3.01
AstroDon part - MMOAG-STL-L	0.75	2.26
SLT Back Focus	1.47	0.79

STL camera and MMOAG		
8.81 remaining BF		
Focuser racked in	3	5.81
Focuser position (0-1.3")	0.59	5.22
LowProfile SecureFit Spacer - 0.5", 600327&328	0.5	4.72
SecureFit 1/2" Spacer - 200377	0.5	4.22
SecureFit 1/2" Spacer - 200377	0.5	3.72
CCD SecureFit to MMOAG - 200394	0.55	3.17
Monster MOAG	1.25	1.92
AstroDon part - MMOAG-STL-S	0.1	1.82
FW8	0.35	1.47
SLT Back Focus	1.47	0

or
ASTRODON
Dovetail to STL
threads male.
Optical path=.1
MMOAG-STL-S

PLANEWAVE INSTRUMENTS
CDK 20 AND 24 SPACERS FOR STL CAMERAS

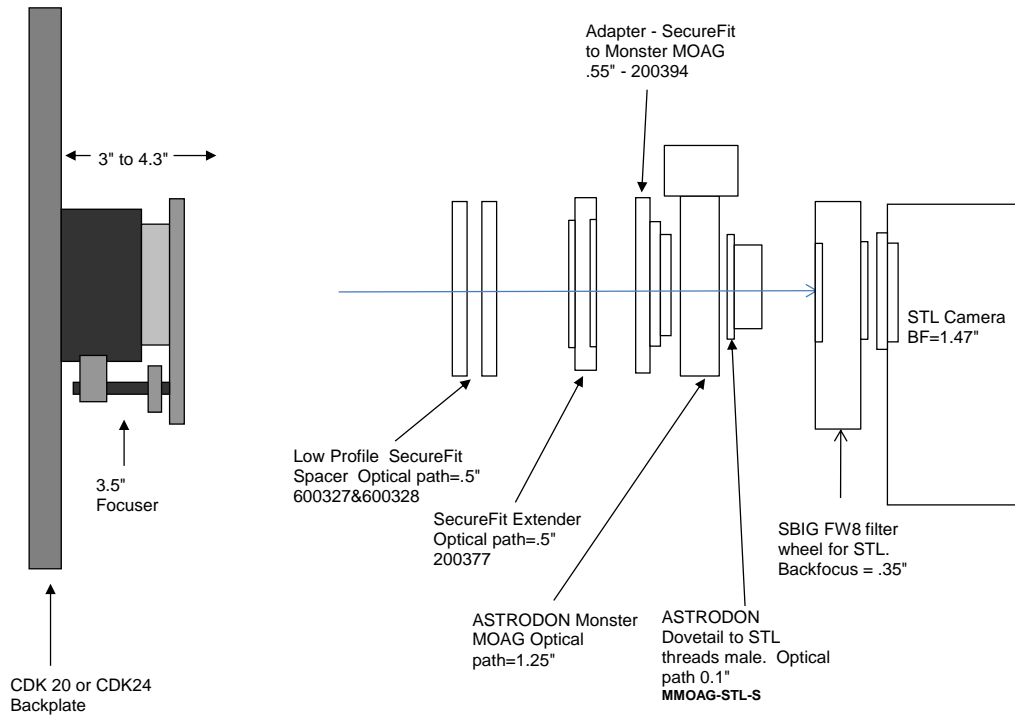

STL camera and MMOAG	8.81 remaining BF	
Focuser racked in	3	5.81
Focuser position (0-1.3")	0.59	5.22
LowProfile SecureFit Spacer - 0.5", 600327&600328	0.5	4.72
SecureFit 1/2" Spacer - 200377	0.5	4.22
SecureFit 1/2" Spacer - 200377	0.5	3.72
CCD SecureFit to MMOAG - 200394	0.55	3.17
AstroDon part - MMOAG	1.25	1.92
AstroDon part - MMOAG-STL-S	0.1	1.82
Filter Wheel, FW8	0.35	1.47
SLT Back Focus	1.47	0

STL Camera and Accessory Backfocus Measurements

STL Backfocus with D-block	1.47	assumes there are filters in the internal filterwheel
STL Backfocus without D-block	1.195	
FW8-STL Filter wheel	0.35	replaces the front of the STL camera and has the same hole pattern as the front plate of the STL
AO-L	1.49	front surface is just like the STL mounting block. It has 4 holes spaced 1.9" apart and the same 2.1" threaded hole in the center
STX	1.39	Optical back focus
STX Filter Wheel	2.68	Adds 1.26" of optical back focus

STL with FW8 1.82 inches of back focus

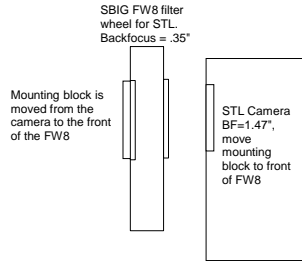

STL + FW8 + AO-L 3.31 inches of back focus

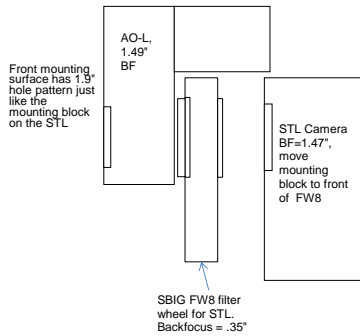

STL with MOAG and AO-L 5.335 inches of back focus

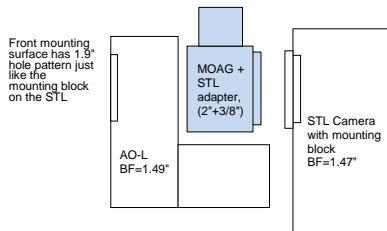

STL Camera's and Filter Wheels - courtesy of SBIG

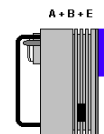
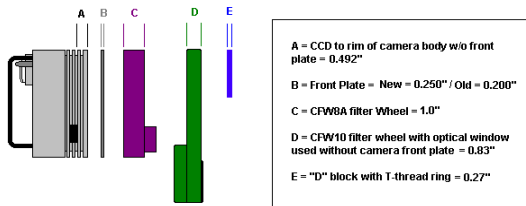

Normal configuration of camera from the factory: Camera with front plate and "D" block containing T-thread ring

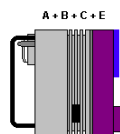

Camera with front plate, CFW8A mounted to camera front plate, "D" block mounted on telescope side of CFW8A

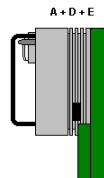

Camera without front plate, CFW10 with optical window replaces front plate, "D" block mounted to telescope side of CFW10